



Guidance for Service Termination Issue Reporting

**A guide for MOCOPA Operators on reporting and acting on
Distribution Business asset condition issues**

Version: 3.7
Status: Final
Date: July 2021



Change History

| Version Number | Status | Date of Issue | Reason for Change | Change Control Reference |
|----------------|----------|---------------|--|---|
| 1.0 | Draft | 16/04/2013 | 1 st Version | |
| 1.1 | Draft | 22/05/2013 | Following comments | |
| 1.2 | Draft | | Following MOCOPA Review Panel May 2013 | |
| 1.3 | Draft | | Following workgroup | |
| 2.0 | Approved | 01/07/2013 | MOCOPA Review Panel Approval | |
| 2.1 | Draft | 06/02/2014 | Following workgroup | |
| 2.2 | Draft | | Following ENA review | |
| 2.3 | Draft | 07/05/2014 | Following ENA review | |
| 2.4 | Draft | 20/06/2014 | Following workgroup | |
| 2.5 | Draft | 06/08/2014 | Following ENA review | |
| 2.6 | Draft | 04/09/2014 | Following workgroup | |
| 2.7 | Draft | 09/09/2014 | Following workgroup | |
| 2.8 | Draft | 18/05/2015 | Following workgroup | |
| 2.9 | Draft | 15/06/2015 | Following workgroup | |
| 3.0 | Draft | 27/07/2015 | Following workgroup member review | |
| 3.1 | Final | 09/10/2015 | Following ENA and MOCOPA joint review | |
| 3.2 | Final | 30/10/2015 | Following MOCOPA Review Panel Oct 2015 | |
| 3.3 | Final | 02/11/2015 | Correcting formatting errors | |
| 3.4 | Final | 07/02/2017 | Following MOCOPA and ENA Review | Review only includes A04, A07 and C15. |
| 3.5 | Final | 30/01/2018 | Following MOCOPA and ENA Review | Fundamental review to reflect the code changes in MRA |
| 3.6 | Final | 04/11/2019 | Review to eliminate inconsistencies and general update | |
| 3.7 | Final | 19/07/2021 | Following MOCOPA and ENA Review | Update to B07 |

Quality Assurance

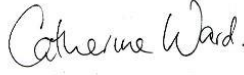
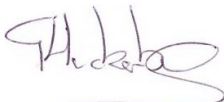
| Name | Responsibility | Signature | Date |
|--------------------------------|----------------|--|------------|
| Author: | | | |
| Energy Networks Association | Paul Abreu |  | 19/07/2021 |
| Association of Meter Operators | Geoff Huckerby |  | 19/07/2021 |
| MOCOPA Registration Authority | Catherine Ward |  | 19/07/2021 |
| Reviewer(s): | | | |
| All MOCOPA Parties | Catherine Ward |  | 19/07/2021 |
| Approved: | | | |
| MOCOPA Review Panel | Geoff Huckerby |  | 19/07/2021 |

© 2017

All rights reserved. No part of this publication may be reproduced, stored in a retrieval system or transmitted in any form or by any means, electronic, mechanical, photocopying, recording or otherwise, unless you are a current MOCOPA Party or with the prior written consent of MOCOPA. Specific enquiries concerning this document should be addressed to:

MOCOPA Registration Authority
 8 Fenchurch Place
 London
 EC3M 4AJ
MOCOPA@gemserv.com



In the event that there is any conflict or contradiction between this Guidance for Service Termination Issue Reporting (Guide), and governing industry documents referenced in this Guide, the terms of the referenced documents will prevail. These include inter alia the Meter Operation Code of Practice Agreement (MOCOPA), the MRA Data Transfer Catalogue, and the MOCOPA Guideline for Service Termination Asset Reporting.

Contents

Contents 1

1. Introduction 6

1.1 What is the aim of this Guide and who is it for? 6

1.2 Format and structure of the Guide 6

1.3 Finding your way in and around the Guide 6

1.4 Principles of reporting 6

1.5 Rising Mains and Lateral Services 7

1.6 Future updates to this Guidance 8

1.7 Governance 8

1.8 References 8

2. Diagram of Equipment Responsibility 9

3. Flow Chart 10

4. List of Asset Condition Codes 11

5. Category A Issues 13

6. Category B Issues 35

7. Category C Issues/Information 52

Appendix I 73

Appendix II 74

Appendix III 76

Appendix IV 77

1. Introduction

1.1 What is the aim of this Guide and who is it for?

Recognising the likelihood of increased activity at service positions during the Smart meter rollout a number of organisations identified a series of defects that Meter Operatives might come across and gave each one a unique asset condition code (Code) for reporting purposes. The Codes are used to report defects and information that relate to Distribution Business (DB) owned equipment.

Meter Operators are authorised under MOCOPA and their Meter Operatives will be competent to recognise and manage the on-site safety of any defects identified.

This Guide is intended to support electricity Meter Operatives in making a correct diagnosis, give direction on the actions Meter Operatives should take, and help Meter Operatives to determine the most appropriate asset condition Code for reporting purposes. Meter Operatives are the primary audience for this Guide; however, it is also intended to assist MOCOPA Operator staff, meter readers and other electricity suppliers' agents (such as revenue protection staff), together with DB staff. It is the responsibility of staff on site to report the defect, and it is inappropriate to pass this responsibility on to the customer.

If you come across a dangerous issue involving DB equipment that is not covered here, telephone the relevant DB immediately.

1.2 Format and structure of the Guide

The Guide contains:

- Information on how to identify the DB;
- A diagram of equipment responsibility;
- A simplified decision flow chart - to help to identify which category of Codes is appropriate;
- A list of the asset condition Codes;
- A "guidance sheet" for each of the asset condition Codes, containing:
 - The Code and description;
 - Guidance details, which describe the issue, give examples, and clearly state the actions to be taken.

1.3 Finding your way in and around the Guide

There are two ways to navigate this document:

- List of Codes – a quick reference for all of the Codes;
- Simplified flow chart – a series of questions, which aims to identify which category of Codes you should refer to in Section 4.

Guidance sheets are presented in the order of the Codes, from A to C.

1.4 Principles of reporting

General principles of reporting the Codes presented in this Guide include:

- Category A Codes must be reported by telephone and **NOT** be sent via data flow;
- Category A issues A01, A05, A10, A14, A17 and A19 **MUST NOT** be left unattended under any circumstances;

- For category A issues, A03, A04, A07, A12, and A15, it is permissible for the Meter Operator to allow their Meter Operatives to undertake mitigating actions to ensure safety, install the meter and leave site;
- Category B Codes **MUST ONLY** be reported when the issue prevents you from installing and energising the meter;
- Category C Codes are used to inform the DB of asset issue(s) / information about DB equipment only and **MUST NOT** prevent metering work from being carried out;
- Only report one Code per MPAN e.g. a B flow **SHOULD NOT** be sent if an A Code has been reported by telephone;
- Where there are multiple DB related issues at one MPAN, report the most serious one using the relevant Code. Report the additional issues using the free text field or if reporting a category A issue mention any additional issues to the DB call agent;
- You must seek to resolve all problems within your remit;
- If you damage the DB equipment or lose any of its components during the course of your work, you must report the matter to the DB via an appropriate Code contained within this guide;
- Where a DB equipment defect is noticed on adjacent DB equipment to which the Meter Operator is not appointed, the DB should be contacted by telephone under business as usual processes;
- It is the Meter Operative's responsibility to report the defect, and it is inappropriate to pass this responsibility on to the customer;
- Defects must be reported to the DB as they arise; they must not be stored up and reported in batches.

Note: that the Codes only apply to DB equipment. If an issue relates to Supplier or customer equipment, you must follow your own organisation's procedures for managing such occurrences. A diagram of equipment responsibility is included in this Guide in Section 2.

Appendix II includes a table with information of how to identify the DB equipment owner by the first two digits of the MPAN number. This is the organisation to contact for reporting any of the Codes detailed within this Guide.

1.5 Rising Mains and Lateral Services

DBs have provided guidance on the ownership of rising and lateral mains which should be adhered to. Where facilities are provided to check ownership and are made available these should be used as confirmation that the report is provided to the correct responsible party.

Rising mains and lateral services are installed in all areas of GB and are used as a means of providing electricity supplies within multi occupancy buildings. The types of buildings which may have rising mains and lateral services installed within them may vary significantly ranging from buildings with as few as two individual properties to large multi storey buildings with hundreds of individual flats.

Defects should only be reported to the DB where it is clear that they are responsible for the operation and maintenance of rising mains and lateral services within the property where a defect has been identified. If the DB is not responsible for the operation and maintenance of rising mains and lateral services within the property a report will need to be sent to the Building Network Operator. If you are unsure regarding who a defect should be reported to contact your supervisor.

1.6 Future updates to this Guidance

This Guide is subject to review to reflect industry changes as they arise. You should check for revisions to the document on the MOCOPA website from time to time.

1.7 Governance

The control and management of this Guide is held by the MOCOPA[®] Review Panel, in accordance with section 4 of MOCOPA[®]. Any enquires regarding the control and governance of the Guidelines, or any proposals regarding amendments and additions to the Guidelines can be sent to the Registration Authority (mocopa@gemserv.com).

1.8 References

You may wish to refer to the following related industry documents/websites for information:

| | |
|--------------------------------|---|
| MOCOPA | http://www.mocopa.org.uk/ |
| Energy UK | http://www.energy-uk.org.uk/ |
| Association of Meter Operators | http://www.meteroperators.org.uk/ |
| Energy Networks Association | http://www.energynetworks.org/ |

Energy UK Customer Facing Issues Guide

<https://www.energy-uk.org.uk/files/docs/GuidanceforElectricityandGasMeterInstallationCustomerFacingIssues.pdf>

Association of Meter Operator Asbestos Guide Document

<https://meteroperators.org.uk/member-area/information-for-members-1/asbestos/>

2. Diagram of Equipment Responsibility

The following diagram shows a typical domestic set-up. The aim of the diagram is to clarify boundaries of responsibility.

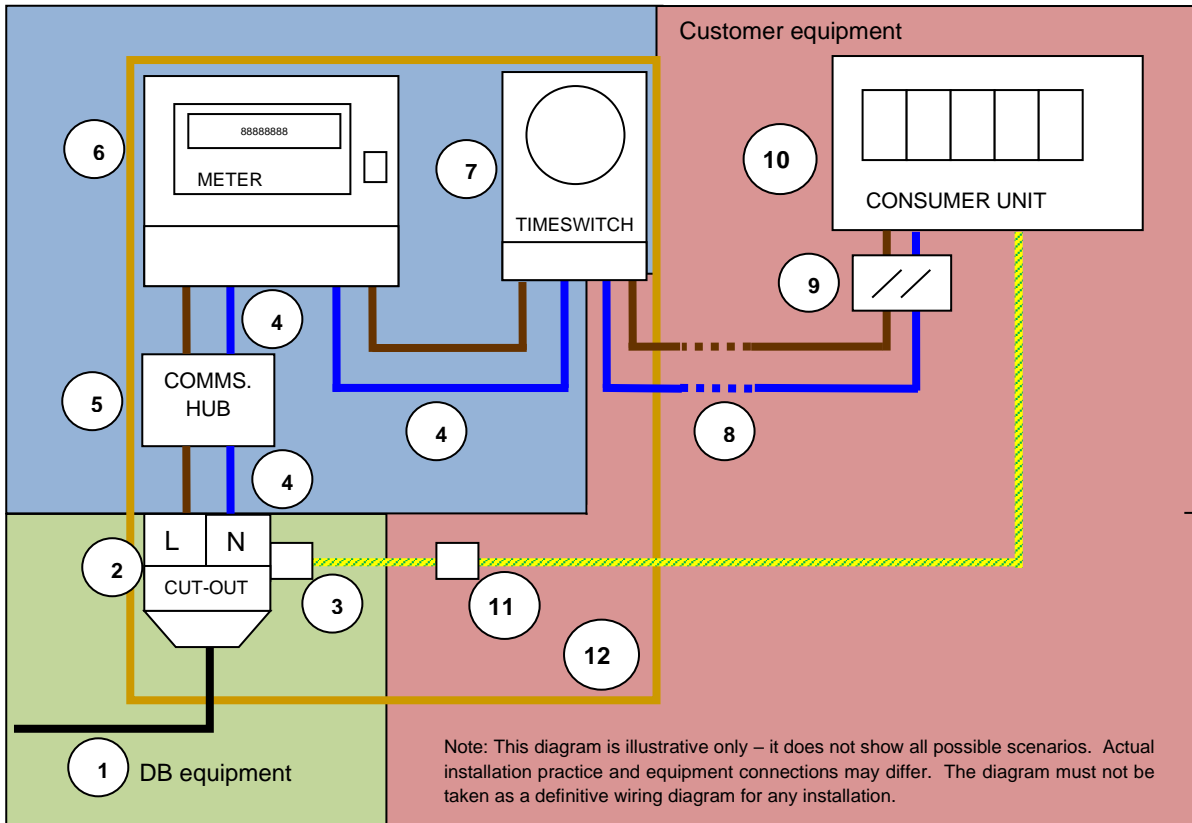

| DB equipment | Supplier equipment | Customer equipment |
|---------------------------------------|--|---|
| 1 - Service cable | 4 - Meter tails (cut-out to meter and meter to timeswitch) | 8 - Meter tails (between the meter / timeswitch and the customer equipment) |
| 2 - Cut-out (or main fuse or DB fuse) | 5 - Communications hub if fitted (may be within the meter) | 9 - Customer isolating switch (if fitted / requested) |
| 3 - DB earth terminal | 6 - Meter | 10 - Customer consumer unit |
| | 7 - Timeswitch (if fitted) | 11 - Customer earthing conductor (and earth block if fitted) |
| | | 12 - Meter board (and external meter box if fitted) |

3. Flow Chart

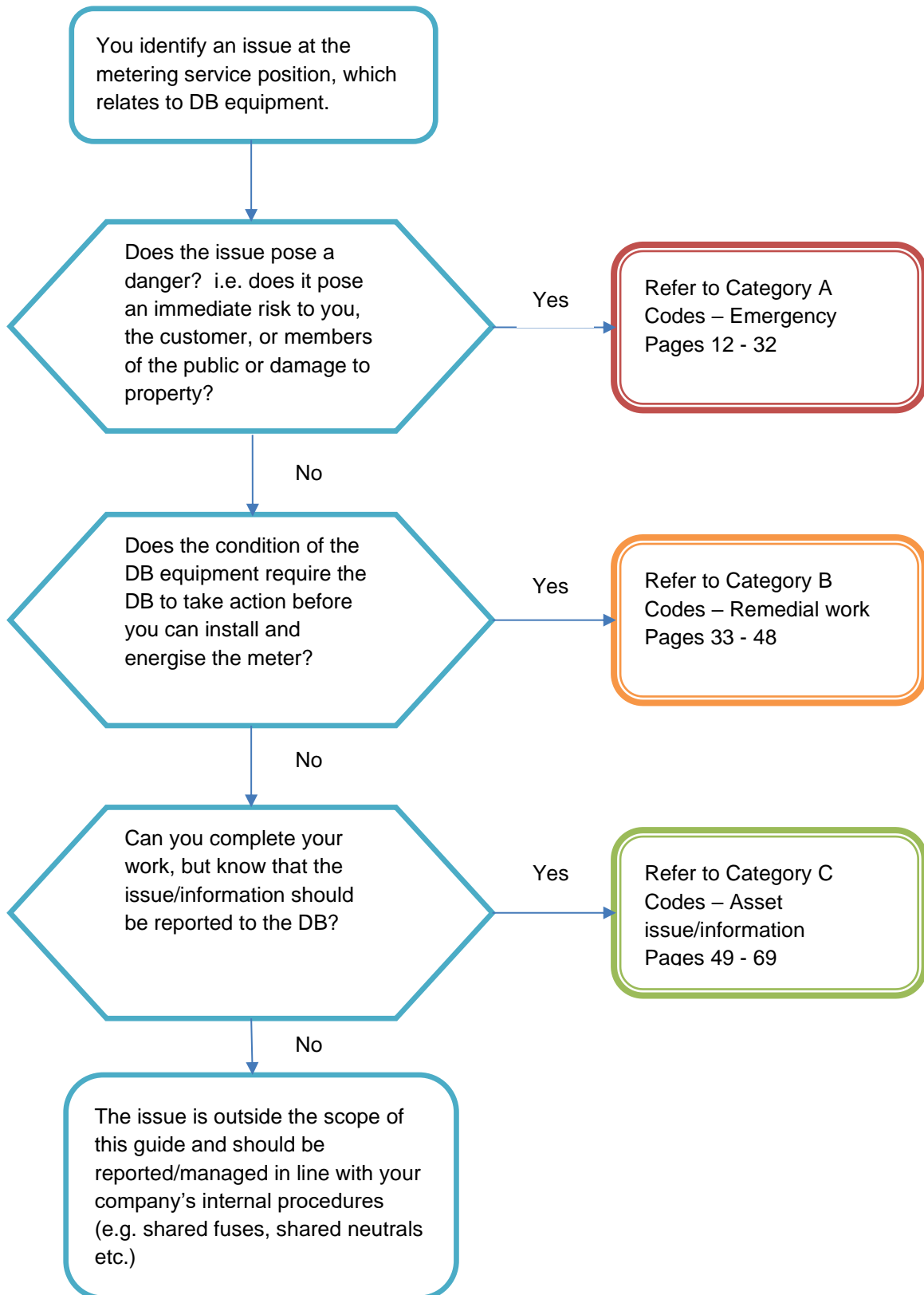

4. List of Asset Condition Codes

The Codes are categorised as follows:

- A. **Emergency Codes** – an issue with the condition of the DB equipment that poses a danger, including danger of death or injury to persons and/or danger of damage to or destruction of property. You must report these issues **IMMEDIATELY** to the DB by telephone whilst you are on site. Refer to “Identifying the Distribution Business” in Appendix II for further details.
- B. **Remedial Work Codes** – an issue with the condition of the DB equipment that prevents metering work (including meter installation/replacement) from being carried out but where the issue is not a category A issue. You must make the site safe and report these issues to the DB using the data flow process.
- C. **Asset Issue/Information Codes** – an issue with/information on the DB equipment that is neither a category A issue nor a category B issue. Report these characteristics to the DB using the data flow process. It is not generally necessary to inform the customer of an Asset Issue/Information Code reported as this may create an unreasonable expectation of DB intervention.

Colour coding helps to distinguish these categories – red for emergency, amber for remedial work and green for asset issue(s)/information.

Category A - Emergency

| Code | Description |
|------|--|
| A01 | DB equipment operating hot (signs of overheating) |
| A03 | Defective/weakened fuse carrier |
| A04 | Physical damage to DB equipment requiring immediate action |
| A05 | Sign of DB equipment burning, smoking or arcing |
| A07 | Exposed live conductor |
| A10 | DB earthing issue at existing installation which presents an immediate risk to Customer/MO |
| A12 | Damaged asbestos component in DB equipment |
| A14 | Polarity identified as incorrect at DB equipment |
| A15 | Immediate risk to the public or Customer due to current service position location |
| A17 | Live unearthed DB metal-encased equipment |
| A19 | Surface voltage found on plastic cut-out |



Category B - Remedial work

Code Description

| | |
|-----|---|
| B01 | Fuse carrier welded in to cut-out base |
| B02 | Cut-out loose |
| B03 | Damaged/missing phase barrier in DB equipment |
| B04 | Damaged/broken cut-out terminal including missing terminal screws |
| B05 | Non-withdrawable fuse by design |
| B07 | DB equipment issue preventing installation/replacement of meter tails |
| B08 | Unhinged metal cut-out cover over un-insulated conductor |
| B10 | Unearthed DB metal-encased equipment |
| B11 | Cut-out with a fused neutral |
| B12 | DB owned CT metering equipment issue |

Category C - Asset issue/information

Code Description

| | |
|-----|--|
| C02 | Signs of bitumen compound leaking |
| C03 | Lower rating fuse or cut-out (less than 60A) |
| C06 | Metal-encased cut-out |
| C07 | DB equipment unable to be securely sealed |
| C11 | Asbestos component identified in DB equipment |
| C14 | Fed from distribution board – local/remote from meter |
| C15 | DB cable terminating into DB equipment is VIR/MICC |
| C16 | DB equipment mounted on asbestos board |
| C17 | Black plastic cut-out |
| C18 | Rewirable cut-out fuse |
| C19 | Single insulated DB conductor (phase or non-PME neutral) |
| C20 | Missing combined neutral-earth cover on DB equipment |

5. Category A Issues

Emergency Codes – an issue with the condition of the DB equipment that poses a danger, including danger of death or injury to persons and/or danger of damage to or destruction of property. You must report these issues **IMMEDIATELY** to the DB by telephone whilst you are on site. Refer to “Identifying the Distribution Business” in Appendix II for further details.

In the interests of customer safety, for category A issues A01, A05, A10, A17 and A19 the Meter Operative, upon identification of a defined issue, **MUST NOT CONTINUE TO OPERATE THE DB EQUIPMENT UNTIL THE ISSUE HAS BEEN RESOLVED BY THE DB**. Report by telephone **IMMEDIATELY** and **REMAIN ON SITE** until the DB arrives.

For category A14 issues, the Meter Operative **MUST REMAIN ON SITE**, however due to the nature of this particular issue the Meter Operative may have to operate the DB equipment prior to the DB attending site.

For category A issues, A03, A04, A07, A12, and A15, it is permissible for the Meter Operator to allow their Meter Operatives to undertake mitigating actions. The Meter Operative can install the meter and leave site after contacting the DB and notifying them of the actions taken to mitigate any danger and whether the meter installation has been completed or not.

Any actions/work carried out by the Meter Operative at site shall be completed in accordance with their company policies and procedures.

If the Meter Operative does undertake mitigating actions and leaves site, a Category A Customer Notification Card (or equivalent) (example in Appendix III) should be left. This is to advise the customer to expect communication from the DB within the next few hours to inspect their equipment and carry out any necessary repairs.

Only one Code should be reported per MPAN. Where there are multiple DB related issues at one MPAN, report the most serious one using the relevant Code. When reporting a category A issue mention any additional issues to the DB call agent.

When reporting a category A (emergency) issue, you must always identify yourself as a Meter Operator and that you want to report a category A (emergency) issue. You should be asked to provide the following information:

- Your full name;
- Your contact telephone number;
- The customer’s name and contact number;
- Any relevant customer priority service register (vulnerability) status (see Appendix IV for categorisation of a vulnerable customer);
- The Code of the most serious defect being reported;
- Any secondary defects and relevant information;
- The status of the supply;
- Location of defect, i.e. address including postcode;
- Meter Point Administration Number (MPAN);
- Who you are working for;
- The registered Supplier for the property;
- Whether the work is associated with the installation of a Smart meter;



- Whether the work is associated with a “gas first” Smart meter installation;
- Whether you are leaving site or not;
- Where further evidence, such as photographs may assist the DB, you may be requested to provide such support.

When you report an issue by telephone you will be provided with a unique job reference number by the DB Emergency Contact Centre on the same call.

Category A – Emergency

Immediately report to the DB by telephone and remain on site until the DB arrives

| | |
|--|--|
| Asset Condition Code: A01 | Code Description: DB equipment operating hot (signs of overheating) |
|--|--|

Description:

The DB cut-out/distribution board or service cable is operating hot and/or showing signs of overheating. This might be due to overload on the customer side, or internal problems within the equipment. Signs include:

- Visual signs of the cut-out or service cable overheating;
- Equipment may smell and be giving off fumes;
- If it is an older type of cable (e.g. paper/lead) it may be discharging an oily substance
- Cut-out leaking bitumen/compound. If you see evidence of minor historic issues do not report A01 and instead report as Code C02;
- Signs of distortion in casing or darkened areas on the outside (modern cut-out).

Actions:

- Do not continue to operate the DB equipment until the issue has been resolved by the DB;
- Keep the immediate area clear of obstructions and keep everyone at a safe distance;
- If the cause appears load-related, advise the customer to reduce their load as appropriate;
- Contact the DB immediately by telephone – report as Code A01;
- Tell the DB what actions you have taken;
- Remain on site until the DB staff arrive;
- Ensure that you have provided all the details to the DB as specified in Section 5 Category A Issues;
- Continue to monitor the issue and inform DB if the situation deteriorates.

Cut-out with visual signs of overheating



Cut-out with signs of bitumen leaking

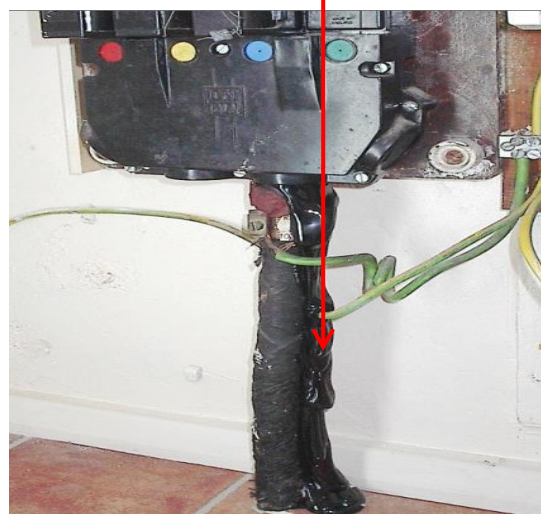

Bitumen

Bitumen has been used for many years to fill voids and seal joints in electrical equipment. It has a relatively low melting point, so bitumen leakage may indicate overheating. The cause of any leakage may be historic, e.g. if previous load patterns or the ambient temperature at the service position are very different to present day arrangements. Alternatively, the cause may be related to an ongoing issue. Recent dust and dirt on the bitumen may help you to distinguish between ongoing and historic issues.

When load is high, bitumen may become hot enough to soften and start to leak, often dripping onto the wall or floor below. Bitumen may also be softened by oils from an oil impregnated cable, which combines with the bitumen and causes it to leak.

If you have any immediate concerns, where the DB equipment is showing serious signs of distress, refer to the actions above. If the DB equipment is not hot but there is minor evidence of historic issues, report as Code C02.

Note: All electrical equipment will experience some degree of heating when current flows. This Code should be used when the heating is considered excessive – this will come down to operative experience. Equipment should not be touched to gauge the temperature, but radiated heat may be sensed. This should prompt more detailed checking for the conditions above.

| Category A – Emergency Immediately report to the DB by telephone | |
|--|--|
| Asset Condition Code: A03 | Code Description: Defective/weakened fuse carrier |

Description:

When you inspect and/or remove the fuse carrier and you see that the fuse carrier contacts are damaged or in such poor condition that arcing has previously occurred or is currently taking place under load conditions.

Other signs include:

- The fuse carrier does not fit firmly within the fuse carrier contacts – the fuse may be loose and may easily fall away;
- The contact in the DB equipment that the fuse inserts into may be broken, cracked or damaged and so overheating and arcing may occur;
- Retaining screws are missing that tighten the forks onto the fuse element;
- Heat discolouration and/or pitting of the fixed contact or carrier contact.

This Code should also be used to report instances:

- Where inappropriate materials (e.g. copper wire) are discovered in place of the correct fuse-wire or cartridge fuse (where it is not possible for the Meter Operative to replace);
- Incompatible fuse carrier used which has led to poor condition due to overheating and/or arcing.

See the next page for a photo example of damaged fuse carrier contacts.

Where it is not safe to replace the fuse carrier which then leaves exposed live conductors, this must be reported as Code A07.

Actions:

- Do not restore the customer’s supply;
- Where possible and safe to do so:

For **PLASTIC** cut-outs:

- Remove the fuse from the fuse carrier;
- Replace the fuse carrier into the cut-out, to make the cut-out safe and remove exposure to live contacts;
- If there are no exposed parts, secure the empty fuse carrier using appropriate seals (as per MOCOPA Appendix 8).

For **METAL-ENCASED** cut-outs and distribution boards:

- Remove the fuse from the fuse carrier;
- Close the cut-out or distribution board cover and re-seal to ensure that the installation is secure.

In all cases:

- If you are remaining on site for the DB to attend, keep the immediate area clear of obstructions and keep everyone at a safe distance;
- Contact the DB immediately by telephone – report as Code A03;

- Tell the DB what actions you have taken, if any;
- Remain on site until the DB staff arrive unless you have been able to take any mitigating actions to prevent danger in accordance with your company's risk assessment policy (see note below);
- If you do undertake mitigating actions and leave site, leave a Category A Customer Notification Card (or equivalent). This is to advise the customer to expect communication from the DB within the next few hours to inspect their equipment and carry out any necessary repairs;
- If you are leaving site, ensure that you have informed the DB that you are leaving;
- Ensure that you have provided all the details to the DB as specified in Section 5 Category A Issues.

Note: The DB recommends that you remain on site. If you leave site, leaving an unsafe situation, you may be breaching your legal obligations under the ESQCR with respect to, but not limited to, (Duty of Cooperation - Part 1, Section 4). You may also be liable for any damage or injury caused as a result of not remaining on site to allow the DB to gain access.

If you choose to leave site, it should be in strict adherence with your company's risk assessment policy. This needs to take into account that by leaving site the DB may not gain access for an unspecified period of time and you may be taking responsibility for the electrical safety associated with this work until such time as the DB gains access.

Weakened fuse carrier contacts

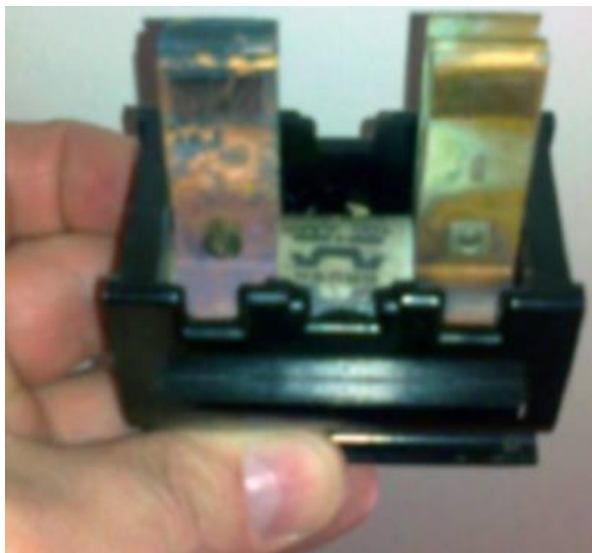

Pitted blade, due to making poor contact



When fuse carriers become overheated they lose their "springiness".

Category A – Emergency

Immediately report to the DB by telephone

| | |
|--|---|
| Asset Condition Code: A04 | Code Description: Physical damage to DB equipment requiring immediate action |
|--|---|

Description:

The DB equipment is damaged e.g. broken or severely cracked/damaged cut-out casing or service cable that requires immediate action (see detailed guidance below).

Examples of damaged service cables include:

- Squashed / deformed service cables (e.g. the cable is squashed flat);
- Cables with severely damaged outer sheathing (e.g. where the conductor itself is visible). As the extent of the service cable damage is often unknown, severely damaged service cables should be reported as A04 regardless of the supply earthing arrangement.

Examples are shown in the photos below:

Severely damaged cut-out casing



Severely damaged service cable

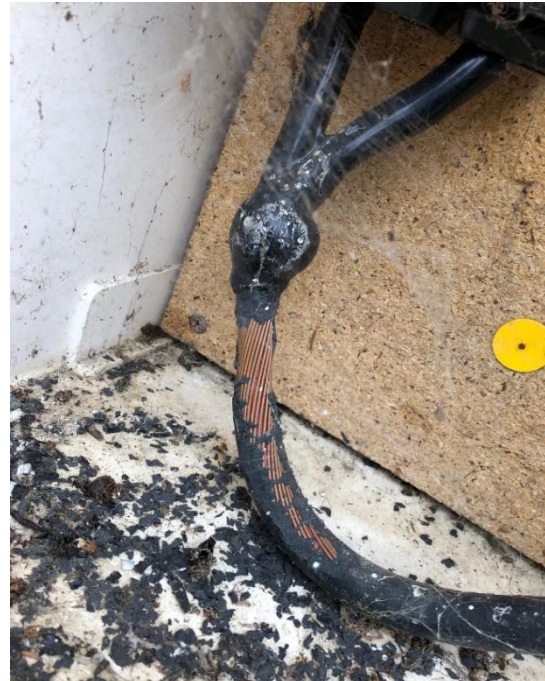

Circumstances where there are exposed live conductors should be reported as Code A07.

Damaged/broken hinges not presenting an immediate danger should be reported as Code B08 when it prevents metering work from being undertaken.

This Code **SHOULD NOT** be used to report missing/damaged earth/neutral-earth terminal access covers or removed knock-outs from a cut-out for the provision of an earth connection. Photo examples shown below:

PME cut-out damaged (but not requiring immediate action) with neutral-earth terminal exposed by missing cover – report as Code C20

Knock out missing and the neutral-earth is exposed – do not report



Actions:

- Do not continue to operate the DB equipment – unless mitigating actions have been taken to allow work to continue;
- If you are remaining on site for the DB to attend, keep the immediate area clear of obstructions and keep everyone at a safe distance;
- Contact the DB immediately by telephone – report as Code A04;
- Tell the DB what actions you have taken, if any;
- Remain on site until the DB staff arrive unless you have been able to take any mitigating actions to prevent danger in accordance with your company's risk assessment policy (see note below);
- If you do undertake mitigating actions and leave site, leave a Category A Customer Notification Card (or equivalent). This is to advise the customer to expect communication from the DB within the next few hours to inspect their equipment and carry out any necessary repairs;
- If you are leaving site, ensure that you have informed the DB that you are leaving;
- Ensure that you have provided all the details to the DB as specified in Section 5 Category A Issues.

Note: The DB recommends that you remain on site. If you leave site, leaving an unsafe situation, you may be breaching your legal obligations under the ESQCR with respect to, but not limited to, (Duty of Cooperation - Part 1, Section 4). You may also be liable for any damage or injury caused as a result of not remaining on site to allow the DB to gain access.

If you choose to leave site, it should be in strict adherence with your company's risk assessment policy. This needs to take into account that by leaving site the DB may not gain access for an unspecified period of time and you may be taking responsibility for the electrical safety associated with this work until such time as the DB gains access.

Category A – Emergency

Immediately report to the DB by telephone and remain on site until the DB arrives

| | |
|--|--|
| Asset Condition Code: A05 | Code Description: Sign of DB equipment burning, smoking or arcing |
|--|--|

Description:

Burning or smoking or audible sound of arcing from the DB equipment indicate that there is a severe problem with the equipment and action must be taken immediately.

Actions:

- Do not continue to operate the DB equipment until the issue has been resolved by the DB;
- Keep the immediate area clear of obstructions and keep everyone at a safe distance;
- If the cause appears load-related, advise the customer to reduce their load as appropriate;
- Contact the DB immediately by telephone – report as Code A05;
- Tell the DB what actions you have taken;
- Remain on site until the DB staff arrive;
- Ensure that you have provided all the details to the DB as specified in Section 5 Category A Issues;
- Continue to monitor the issue and inform DB if the situation deteriorates.

Category A – Emergency
Immediately report to the DB by telephone

| | |
|--|---|
| Asset Condition Code: A07 | Code Description: Exposed live conductor |
|--|---|

Description:

This Code should be used for reporting exposed live conductors or terminals only when associated with DB equipment; this means:

- Reporting exposed phase conductors;
- Reporting exposed neutral conductors associated with non-PME supplies;
- Reporting broken fuse carriers with access to live conductors.

Examples of what is reportable and is not reportable are shown in the photos below as well as the section 'Explanation of earthing arrangements'.

Photo examples – Exposed conductors

These are examples of cut-outs showing visible bare conductors from the cable termination to the fuse unit.

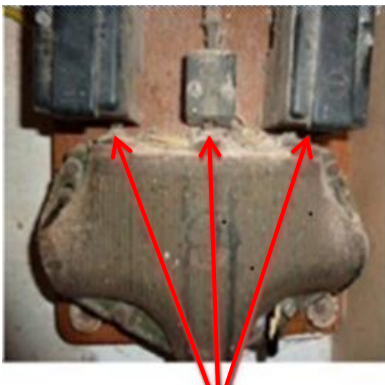

Visible bare conductors

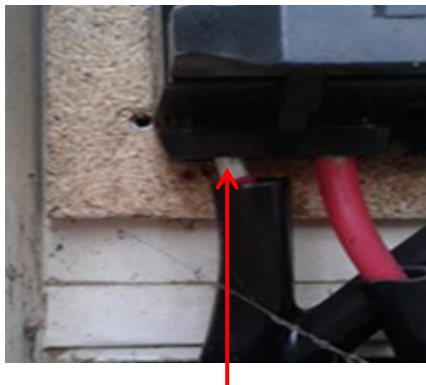

Exposed live conductor where the insulated trousers have slipped exposing the live conductor



Visible bare conductors

Code A07 SHOULD NOT be used where:

- Earth terminals are exposed by design (e.g. some distribution boards and cut-outs have external earth terminals or where cut-outs have knock-outs for the provision of an earth connection);
- Combined neutral-earth conductors or terminals forming part of the cut-out or the incoming service cable are exposed (not by design). Report as Code C20;
- The cut-out structure may be defective but live terminals are undisturbed and cannot be touched or interfered with without using tools. This should be reported under the appropriate Code e.g. C20 or C07;
- There are missing combined neutral-earth covers. Report as Code C20;
- There are issues with designed access points to protection chambers, but the live conductors or terminals cannot be touched or interfered with without using tools etc;

- Blanking plugs are missing from meter tail access points – these access points should be made safe by the Meter Operative;
- The installed meter tails do not completely fill the cable entry access on the DB equipment. In these situations, it is the responsibility of the Meter Operative to take appropriate remedial action which may include in the first instance to re-terminate the meter tails. Other options which should be considered include the use of an appropriate sealant, grommets and/or security/safety collars where appropriate;
- A meter position change would create a potential category A issue that was not previously present and cannot be rectified by the Meter Operative e.g. changing the location of a meter which would expose live conductors in the cut-out that were previously covered by the meter. In this situation the meter position must not be altered and the issue reported as Code B07. To ensure the DB is aware of why a seemingly serviceable cut-out should be replaced, it is important to state the reason why in the free text field;
- Any live single insulated DB service conductor does not have any other mechanical protection provided. This type of issue should be reported as Code C19.

Examples of non-reportable events taking account of the earthing arrangement

Where cut-outs have missing 'knock outs or earth terminal access covers' as shown below; these **SHOULD NOT** be reported under any Code as they are specifically designed to provide access to the earth terminal.

Earth terminal cover in place



Earth terminal cover missing and the neutral-earth is exposed – do not report

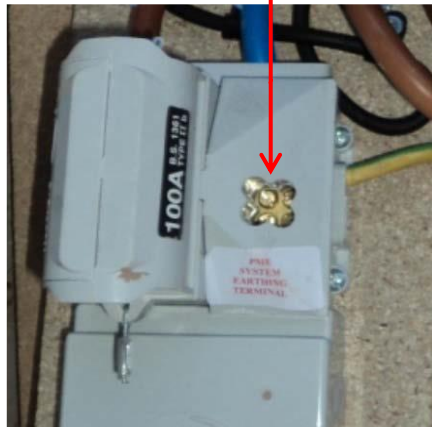

Knock out missing and the neutral-earth is exposed – do not report



Actions:

- Do not continue to operate the DB equipment – unless mitigating actions have been taken to allow work to continue;
- If you are remaining on site for the DB to attend, keep the immediate area clear of obstructions and keep everyone at a safe distance;
- Contact the DB immediately by telephone – report as Code A07;
- Tell the DB what actions you have taken, if any;
- Remain on site until the DB staff arrive unless you have been able to take any mitigating actions to prevent danger in accordance with your company's risk assessment policy (see note below);

- If you do undertake mitigating actions and leave site, leave a Category A Customer Notification Card (or equivalent). This is to advise the customer to expect communication from the DB within the next few hours to inspect their equipment and carry out any necessary repairs;
- If you are leaving site, ensure that you have informed the DB that you are leaving;
- Ensure that you have provided all the details to the DB as specified in Section 5 Category A Issues.

Note: The DB recommends that you remain on site. If you leave site, leaving an unsafe situation, you may be breaching your legal obligations under the ESQCR with respect to, but not limited to, (Duty of Cooperation - Part 1, Section 4). You may also be liable for any damage or injury caused as a result of not remaining on site to allow the DB to gain access.

If you choose to leave site, it should be in strict adherence with your company's risk assessment policy. This needs to take into account that by leaving site the DB may not gain access for an unspecified period of time and you may be taking responsibility for the electrical safety associated with this work until such time as the DB gains access.

Explanation of earthing arrangements

The vast majority of earthing arrangements encountered in the UK will be TN-S (SNE), TN-C-S (PME) or TT.

TN-S (SNE) earthing arrangement

This is where the service cable has a separate neutral and earth (SNE) conductor at the service position. The earth is usually provided by the metallic cable sheath or a dedicated conductor as part of the cable design. Examples shown below are for presentation purposes only which includes intentional removal of the terminal crutch covers.

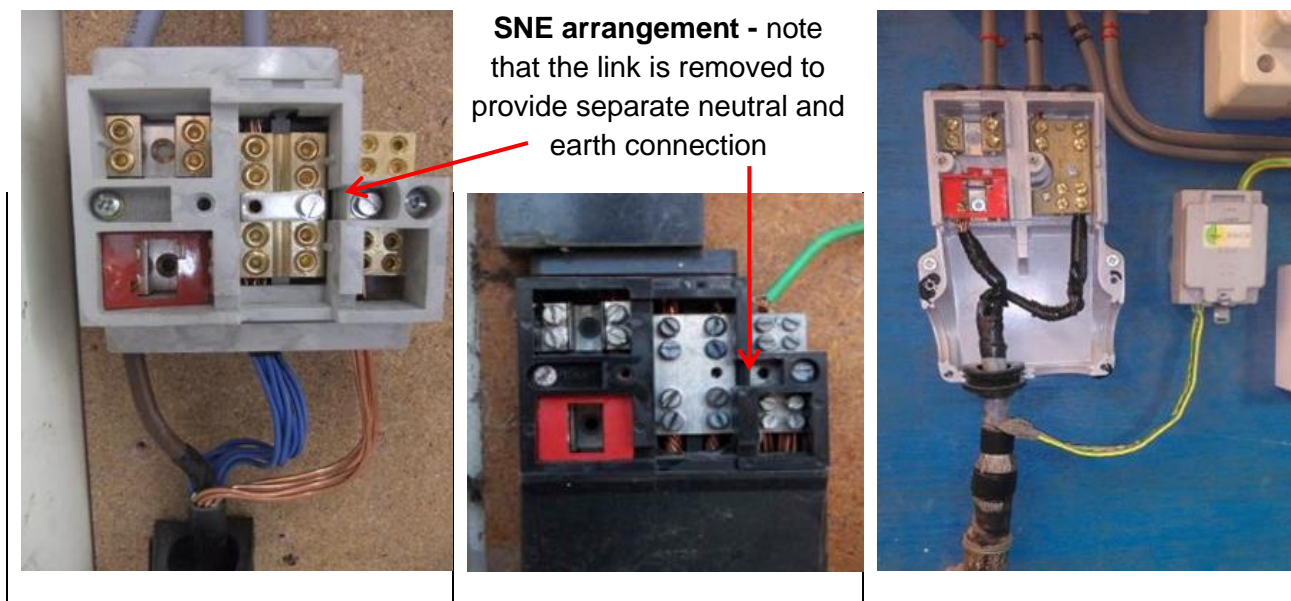

TN-C-S (PME) earthing arrangement

This is where the service has a combined neutral and earth conductor terminated at the service position and bonded to the customer's installation or in the case of new supplies, is ready for connection. Examples shown below are for presentation purposes only which includes intentional removal of the terminal and crutch covers.

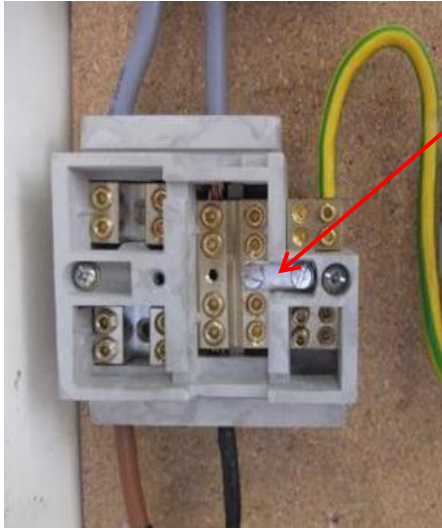

PME arrangement -
note separate neutral and earth block with link inserted to create PME connection arrangement

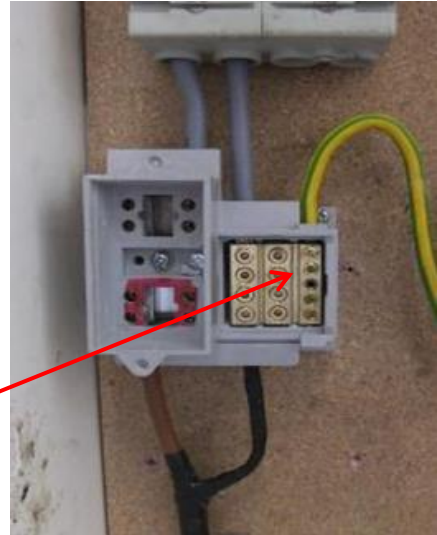

PME arrangement -
note single connection point for both neutral and earth conductors

TT earthing arrangement

This is where the DB **DOES NOT** provide an earth connection via their DB equipment and is normally recognised by the lack of any earth connection to the incoming supply cable or cut-out.

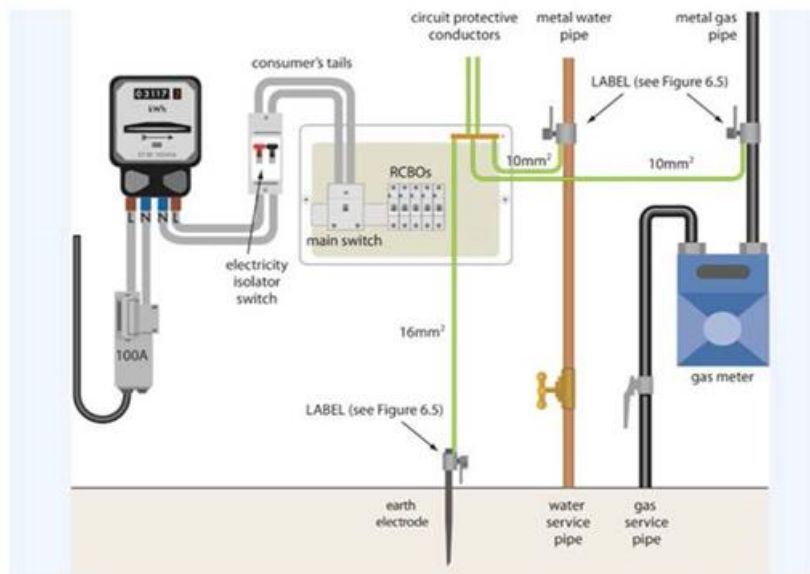

Category A – Emergency

Immediately report to the DB by telephone and remain on site until the DB arrives

| | |
|--|---|
| Asset Condition Code: A10 | Code Description: DB earthing issue at existing installation which presents an immediate risk to Customer/MO |
|--|---|

Note:

This Code does not relate to the provision of new earthing facilities. Requests for new earthing connections follow a different process: they should be applied for by the customer or their representative.

Description:

There is an immediate risk to the customer due to deterioration of, or damage to, an earth terminal provided by the DB. For example, there is clearly a DB earth terminal used to protect the customer's installation, but you have reason to believe that it is ineffective (e.g. high earth loop impedance) **OR** the DB earth has been previously provided but has been removed or become otherwise defective.

Examples of reasons for believing the earthing is ineffective include:

- A nil/low/intermittent lamp glow with test lamps (phase-earth terminal);
- A loose earth clamp (do not attempt to tighten);
- Severely corroded DB earth connection.

Where there are earthing problems with the customers' installation, notify the customer, who may need to ensure an electrician attends to check their installation.

Note: Live unearthed DB metal-encased equipment should be reported as Code A17. Report unearthed but **NOT LIVE** DB metal-encased equipment as Code B10.

Actions:

- Identify whether this is an issue to report to the DB or to discuss with the customer (see guidance below). If it is a DB issue:
- Do not continue to operate the DB equipment until the issue has been resolved by the DB;
- Keep the immediate area clear of obstructions and keep everyone at a safe distance;
- Contact the DB immediately by telephone – report as Code A10;
- Tell the DB what actions you have taken, if any;
- Remain on site until the DB staff arrive;
- Ensure that you have provided all the details to the DB as specified in Section 5 Category A Issues.

Guidance: Is this a DB or customer issue?

It is always the customer's responsibility to make sure that their installation is effectively earthed. Any concerns over whether their installation has been effectively earthed (e.g. shocks from light switches or broken or missing leads) must be raised with the customer.

Many properties will never have used a DB earth – so just because you cannot see an earth connection, does not mean that there is a problem. For example, many properties use their own earth stake with an earth leakage protective device.

For those properties where a DB earth terminal has clearly been provided and was previously used by the customer's electrician to provide a main earth, then:

- a) If the earth lead away from the DB earth terminal is damaged, you must tell the customer; or
- b) If the DB earth terminal itself is damaged, you must ring the DB immediately, reporting this under A10 (above).

In any case, if you think that there is no effective earth, switch off consumer unit(s) or isolator(s).

What other actions could I take?

The photos below illustrate an earth connection using an earth clamp around the sheath of the service cable. If the clamp/connection is loose, do not tighten it, as this could potentially lead to cable damage and catastrophic failure. Loose earth connections attached to other parts of the DB equipment e.g. on a terminal at the side of a cut-out, may be tightened.



Screw missing from the earth clamp.

Socket tester indicates an earthing issue but further tests are required to confirm that the whole installation is not adequately earthed. If confirmed. Report as Code A10.

Category A – Emergency

Immediately report to the DB by telephone

| | |
|--|---|
| Asset Condition Code: A12 | Code Description: Damaged asbestos component in DB equipment |
|--|---|

Description:

There is asbestos in the DB equipment (e.g. cut-out, distribution board) and it is damaged. If asbestos is present but not damaged, report as Code C11.

Note 1: Defects to asbestos meter boards that do not have DB equipment attached should not be reported to the DB.

Note 2: If the cut-out is mounted on an asbestos board you should report these to the DB as Code C16.

Actions:

If you inspect the DB equipment and discover that there is asbestos material in it, and it is damaged:

- Do not continue to operate the DB equipment;
- If you are remaining on site for the DB to attend, keep the immediate area clear of obstructions and keep everyone at a safe distance;
- Contact the DB immediately by telephone – report as Code A12;
- Tell the DB what actions you have taken, if any;
- Remain on site until the DB staff arrive unless you have been able to take any mitigating actions to prevent danger in accordance with your company's risk assessment policy (see note below);
- If you do undertake mitigating actions and leave site, leave a Category A Customer Notification Card (or equivalent). This is to advise the customer to expect communication from the DB within the next few hours to inspect their equipment and carry out any necessary repairs;
- If you are leaving site, ensure that you have informed the DB that you are leaving;
- Ensure that you have provided all the details to the DB as specified in Section 5 Category A Issues.

An AMO document "Guidance to manage asbestos during metering activities" provides guidance to companies in developing their own asbestos safe working procedures. This will allow your company to update their asbestos procedures, which you must follow in the event of encountering asbestos-based materials.

Note: The DB recommends that you remain on site. If you leave site, leaving an unsafe situation, you may be breaching your legal obligations under the ESQCR with respect to, but not limited to, (Duty of Cooperation - Part 1, Section 4). You may also be liable for any damage or injury caused as a result of not remaining on site to allow the DB to gain access.

If you choose to leave site, it should be in strict adherence with your company's risk assessment policy. This needs to take into account that by leaving site the DB may not gain access for an unspecified period of time and you may be taking responsibility for the electrical safety associated with this work until such time as the DB gains access.

Category A – Emergency

Immediately report to the DB by telephone and remain on site until the DB arrives

| | |
|--|---|
| Asset Condition Code: A14 | Code Description: Polarity identified as incorrect at DB equipment |
|--|---|

Description:

You discover incorrect polarity on the incoming service cable to the DB equipment when you are carrying out the polarity check.

Any cross polarity beyond the outgoing side of the DB equipment is the responsibility of the MOCOPA Operator or customer dependent upon the point at which the cross polarity is identified. Follow your company policy.

Note: In certain situations, exposed metal work may still be live (and remain live with the fuse removed) and this should be part of your risk assessment when making the site safe. Isolating the customer's supply by switching off the consumer unit/double pole isolator or removing the cut-out fuse could leave the customer's installation in a less safe condition than before.

Actions:

- Consider whether other customers may be affected e.g. due to a shared or looped service and advise DB of this when making your report;
- Re-insert the fuse into the cut-out if you have removed it;
- Switch the consumer unit/double pole isolator back on if you have switched it off as part of your work;
- Do not continue to operate the DB equipment until the issue has been resolved by the DB;
- Contact the DB immediately by telephone – report as Code A14;
- Tell the DB what actions you have taken;
- Remain on site until the DB staff arrive;
- Ensure that you have provided all the details to the DB as specified in Section 5 Category A Issues.

Category A – Emergency

Immediately report to the DB by telephone

| | |
|--|--|
| Asset Condition Code: A15 | Code Description: Immediate risk to the public or Customer due to current service position location |
|--|--|

Description:

You discover that the service position is unsafe and poses an immediate risk to the customer or public. Examples of unsafe locations and situations include:

- Service position insecure or exposed to immediate weather damage;
- In a shower, wet area or bathroom;
- In a flooded cellar;
- Where there is a flammable environment or an explosive atmosphere, which cannot be addressed by the customer;
- Near a car jet washing facility that is not adequately separated;
- In close proximity to machinery, making it unsafe to work on the service;
- Where the structure to which the service is attached is in danger of collapse;
- Buildings that are not secure against third party access, e.g. abandoned warehouses;
- Where the DB equipment has become detached and is hanging unsupported from its normally secured position.

Note: Where the DB equipment is loose on the meter/backboard and in such a condition that you cannot safely rectify the issue report as Code B02.

Actions:

- Do not continue to operate the DB equipment – unless mitigating actions have been taken to allow work to continue;
- If you are remaining on site for the DB to attend, keep the immediate area clear of obstructions and keep everyone at a safe distance;
- Contact the DB immediately by telephone – report as Code A15;
- Tell the DB what actions you have taken, if any;
- Remain on site until the DB staff arrive unless you have been able to take any mitigating actions to prevent danger in accordance with your company's risk assessment policy (see note below);
- If you do undertake mitigating actions and leave site, leave a Category A Customer Notification Card (or equivalent). This is to advise the customer to expect communication from the DB within the next few hours to inspect their equipment and carry out any necessary repairs;
- If you are leaving site, ensure that you have informed the DB that you are leaving;
- Ensure that you have provided all the details to the DB as specified in Section 5 Category A Issues.

Note: The DB recommends that you remain on site. If you leave site, leaving an unsafe situation, you may be breaching your legal obligations under the ESQCR with respect to, but not limited to, (Duty of Cooperation - Part 1, Section 4). You may also be liable for any damage or injury caused as a result of not remaining on site to allow the DB to gain access.



If you choose to leave site, it should be in strict adherence with your company's risk assessment policy. This needs to take into account that by leaving site the DB may not gain access for an unspecified period of time and you may be taking responsibility for the electrical safety associated with this work until such time as the DB gains access.

Category A – Emergency

Immediately report to the DB by telephone and remain on site until the DB arrives

| | |
|--|--|
| Asset Condition Code: A17 | Code Description: Live unearthed DB metal-encased equipment |
|--|--|

Note:

All metalwork associated with the supply should be earthed. Although not ideal, metal-encased covers are generally considered earthed when attached to an earthed box.

Description:

Any circumstances on the site involving DB equipment that has the potential for electric shock or electrocution, which has not been covered in other Codes, including live service or cut-out metalwork, and unearthed service metalwork (e.g. metal-encased cut-out, distribution board, cable gland box).

If unearthed DB equipment is not live report as Code B10.

Actions:

- Do not continue to operate the DB equipment until the issue has been resolved by the DB;
- Keep the immediate area clear of obstructions and keep everyone at a safe distance;
- Contact the DB immediately by telephone – report as Code A17;
- Tell the DB what actions you have taken;
- Remain on site until the DB staff arrive;
- Ensure that you have provided all the details to the DB as specified in Section 5 Category A Issues;
- Continue to monitor the issue and inform DB if the situation deteriorates.

Category A – Emergency

Immediately report to the DB by telephone and remain on site until the DB arrives

| | |
|--|---|
| Asset Condition Code: A19 | Code Description: Surface voltage found on plastic cut-out |
|--|---|

Note:

A potential safety issue has been identified with both single and three phase black plastic cut-outs made from phenolic materials, installed by DBs across the UK between 1967 and 1992, whereby the plastic casing can in some circumstances become conductive leading to a risk of electric shock and/ or excessive heat.

If as part of your risk assessment of the work area, you identify that the cut-out is a plastic cut-out that may contain phenolic material then follow these actions:

- Before the operation of a cut-out - check for surface voltage on the body of the plastic cut-out using an appropriate direct contact voltage measuring device (do not operate the DB equipment if a voltage is detected);
- If a sustained voltage is identified record the voltage value and report this to the DB where possible;
- Reports based on readings from a single point of contact voltage indicator must be confirmed by a second test using an approved two-pole testing device;
- If you are uncertain on the interpretation of your tests, contact your supervisor for further advice;
- A proximity voltage indicator should not be used.

Description:

The DB equipment shows the presence of a voltage on the plastic cut-out casing.

Actions:

If you discover sustained voltage on the surface of the plastic cut-out:

- Do not continue to operate the DB equipment until the issue has been resolved by the DB;
- Keep the immediate area clear of obstructions and keep everyone at a safe distance;
- If the cause appears load-related, advise the customer to reduce their load as appropriate;
- Contact the DB immediately by telephone – report as Code A19;
- Tell the DB what actions you have taken;
- Remain on site until the DB staff arrive;
- Ensure that you have provided all the details to the DB as specified in Section 5 Category A Issues;
- Continue to monitor the issue and inform DB if the situation deteriorates.



Black plastic cut-out

Cut-outs such as these can be constructed of a phenolic material

6. Category B Issues

Remedial Work Codes – an issue with the condition of the DB equipment that prevents metering work (including meter installation/replacement) from being carried out but where the issue is not a category A issue. You must make the site safe and report these issues to the DB using the data flow process.

Any actions/work carried out by the Meter Operative at site shall be completed in accordance with their company policies and procedures.

Category B Code **MUST ONLY** be reported when the issue prevents you from installing the meter.

Where there are multiple DB related issues at one MPAN, report the most serious one using the relevant Code. Report the additional issues using the free text field.

Only report one Code per MPAN e.g. a B Code data flow **SHOULD NOT** be sent if a category A issue has been reported by telephone.

Before commencing work the Meter Operative must ensure that they have all the necessary tools and equipment to complete their task and leave the DB equipment in a safe and serviceable condition.

In the case where an issue is both a Code B11 (cut-out with a fused neutral) and also another B Code, report the prime Code as a B11 with reference made to other issues in the free text field.

You must seek to resolve all problems within your remit.

Where a DB equipment defect is noticed on adjacent DB equipment to which the Meter Operator is not appointed, the DB should be contacted by telephone under business as usual processes.

In the case of all category B issues your actions should be:

- Wherever possible, for safety and security reasons ensure the DB equipment is sealed before leaving site;
- Stop work and do not commence your meter installation activity;
- Report the issue to the DB via the data flow system;
- Provide the DB with the customer's name and contact number using the data flow system;
- To ensure the customer is fully aware of next steps, leave a Category B Customer Notification Card (or equivalent) to advise the customer to expect communication from the DB requesting an appointment to visit site to inspect the DB equipment.

In certain circumstances it may be helpful to the DB to obtain a photograph of the condition being reported. Some DBs may have a process to facilitate the transfer of imagery. If this is available details can be found within the specific DB area of the MOCOPA[®] website.

Category B – Remedial Work

DB work required for you to complete your work

| | |
|--|---|
| Asset Condition Code: B01 | Code Description: Fuse carrier welded in to cut-out base |
|--|---|

Description:

On attempting to remove the DB fuse, in any situation, you are unable to remove the fuse carrier safely. This could be due to corrosion, previous arcing or overheating. The carrier cannot be moved, and any further effort exerted could cause further damage to the DB equipment.

Note: If you discover that an incompatible fuse carrier has been inserted into the cut-out or distribution board, report as Code A03.

If there are immediate signs of arcing or overheating report as Code A01.

Actions:

- Wherever possible, for safety and security reasons ensure the DB equipment is sealed before leaving site;
- Stop work and do not commence your meter installation activity;
- Report the issue to the DB via the data flow system – report as Code B01;
- Provide the DB with the customer’s name and contact number using the data flow system;
- To ensure the customer is fully aware of next steps, leave a Category B Customer Notification Card (or equivalent) to advise the customer to expect communication from the DB requesting an appointment to visit site to inspect the DB equipment.

Fuse carrier welded into cut-out base



A fuse has become stuck due to bitumen compound rising up from the cable box beneath and “gluing” the fuse contacts

Category B – Remedial Work

DB work required for you to complete your work

| | |
|--|--|
| Asset Condition Code: B02 | Code Description: Cut-out loose |
|--|--|

Note:

During your risk assessment you may discover that the meter/backboard is in a loose or poor condition. You must seek to resolve all problems within your remit.

If you are satisfied that you **CAN SAFELY MAKE THE DB EQUIPMENT AND METER SECURE**, you may decide to proceed with your work, in which case do not report.

Description:

Examples of environments where this Code may be used are situations where damp environments, e.g. cellars, sheds or alleyways have resulted in the meter/backboard decaying and the DB equipment has become loose.

If the **DB EQUIPMENT IS INSECURE** and that continuing with your work may result in damage to equipment or risk to yourself, a visit is required by the DB to re-fix their equipment before you can proceed with your work, report as Code B02.

Note: If the condition puts the customer or public at immediate risk report as Code A15.

Actions:

- Wherever possible, for safety and security reasons ensure the DB equipment is sealed before leaving site;
- Stop work and do not commence your meter installation activity;
- Report the issue to the DB via the data flow system – report as Code B02;
- Within the free text field on the data flow, please identify what equipment is located on the meter/backboard (including any customer equipment);
- Provide the DB with the customer’s name and contact number using the data flow system;
- To ensure the customer is fully aware of next steps, leave a Category B Customer Notification Card (or equivalent) to advise the customer to expect communication from the DB requesting an appointment to visit site to inspect the DB equipment.



Examples of a cut-out that is clearly not securely fixed onto a wall



Category B – Remedial Work

DB work required for you to complete your work

| | |
|--|--|
| Asset Condition Code: B03 | Code Description: Damaged/missing phase barrier in DB equipment |
|--|--|

Description:

Internal barriers/covers between phases or phase and neutral or phase and earth metalwork are:

- Significantly damaged (i.e. they cannot perform their function); or
- Missing from the cut-out or other DB equipment.

This will prevent you from removing the fuse, or fuses, safely.

If you suspect that the damaged phase barriers are an asbestos material then report as Code A12.

If the equipment is not damaged, but contains asbestos components then report as Code C11.

Actions:

- Wherever possible, for safety and security reasons ensure the DB equipment is sealed before leaving site;
- Stop work and do not commence your meter installation activity;
- Report the issue to the DB via the data flow system – report as Code B03;
- Provide the DB with the customer’s name and contact number using the data flow system;
- To ensure the customer is fully aware of next steps, leave a Category B Customer Notification Card (or equivalent) to advise the customer to expect communication from the DB requesting an appointment to visit site to inspect the DB equipment.

Examples of cut-outs with removable phase barriers:

Cut-out designs are reliant on a form of phase barrier. In some designs of cut-outs the phase barrier is removable to allow easier access to terminals. The below images are examples of a cut-out with missing phase barriers – you should note that there are many other types of metal-encased cut-outs with similar internal arrangements.

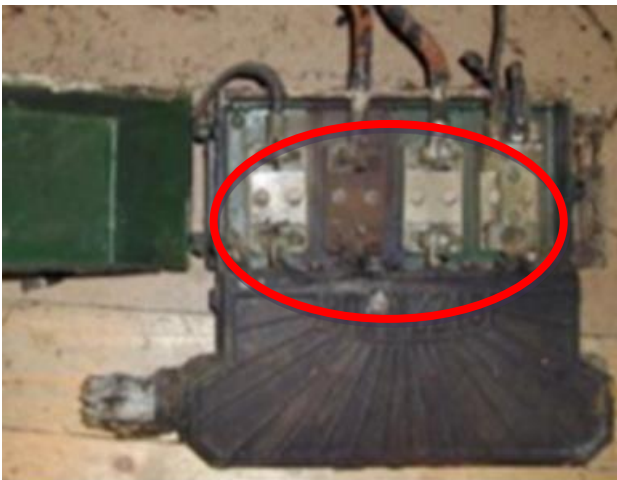

Missing phase barriers. Note the proximity of the incoming “stalks” to the metal cover

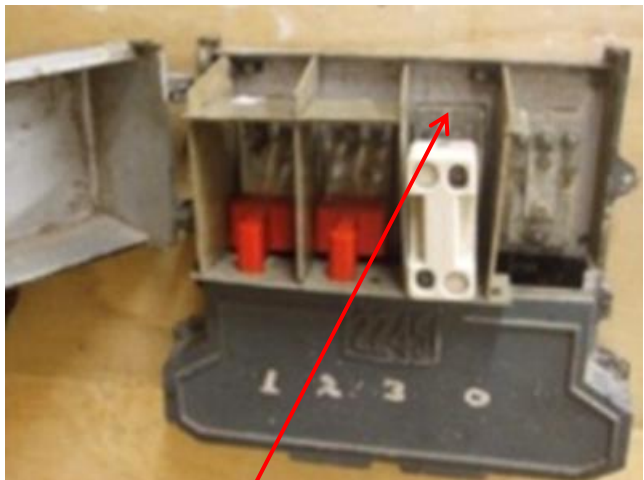

Missing phase barrier. Shrouds (in red) have been used by the Meter Operative to cover the live terminals

Category B – Remedial Work

DB work required for you to complete your work

| | |
|--|--|
| Asset Condition Code: B04 | Code Description: Damaged/broken cut-out terminal including missing terminal screws |
|--|--|

Description:

Following removal of the DB fuse and neutral or neutral/earth cover it is clear that the condition of the outgoing phase and neutral connections will prevent metering work being undertaken.

This will include where terminal screws are missing, but **ONLY** where spare ways aren't available or where there is more than one outgoing cable terminal and only one has missing screws you should proceed with your work by either; using the terminal that is complete or by utilising screws from an unused terminal.

If a terminal screw is found sheared off and unable to be removed but the cable is found fit for purpose and shows no signs of overheating; it can be assumed it sheared off when being fully tightened and you should not report a defect to the DB.

Should meter tails need to be changed and screw is found to be sheared off and can't be removed cease work and report as Code B04.

The screws are designed to be tightened by hand with the appropriate sized screwdriver or tool. If in the course of tightening you shear the screw you may be using excessive force and the screw will be adequately tight. These would not need to be reported under this Code.

If during the course of your works you shear off a termination screw and you cannot confirm tightness report as Code A01 and remain on site for the DB to attend.

Note: In circumstances where spare screws and terminals can be utilised the meter exchange can take place and you should not report a defect to the DB, providing any redundant entry points can be made safe, e.g. by insertion of a blanking plug.

Examples:

Missing screw. Meter Operative
able to continue with work - do
not report



Screw sheared off. Meter
Operative able to continue with
work - do not report

**Actions:**

- Wherever possible, for safety and security reasons ensure the DB equipment is sealed before leaving site;
- Stop work and do not commence your meter installation activity;
- Report the issue to the DB via the data flow system – report as Code B04;
- Provide the DB with the customer's name and contact number using the data flow system;
- To ensure the customer is fully aware of next steps, leave a Category B Customer Notification Card (or equivalent) to advise the customer to expect communication from the DB requesting an appointment to visit site to inspect the DB equipment.

Category B – Remedial Work

DB work required for you to complete your work

| | |
|--|--|
| Asset Condition Code: B05 | Code Description: Non-withdrawable fuse by design |
|--|--|

Note:

This Code should not be used in circumstances where the withdrawal of the cut-out fuse is prevented by an external obstruction such as built-over cupboard etc.

Description:

Any cut-out where the equipment is designed such that the fuse cannot be removed for isolation purposes. Cut-outs with non-withdrawable fuses must not be worked on, as the only way to “operate” the cut-out is to work directly on the live terminals.

Note that in all cases a cut-out with a fused neutral should be reported as Code B11.

Actions:

- Wherever possible, for safety and security reasons ensure the DB equipment is sealed before leaving site;
- Stop work and do not commence your meter installation activity;
- Report the issue to the DB via the data flow system – report as Code B05;
- Provide the DB with the customer’s name and contact number using the data flow system;
- To ensure the customer is fully aware of next steps, leave a Category B Customer Notification Card (or equivalent) to advise the customer to expect communication from the DB requesting an appointment to visit site to inspect the DB equipment.

Examples – Non-withdrawable fuses

The photos below show an example of a cut-out where the fuse wire terminals are attached to the cut-out, hence the fuse is non-withdrawable by design. Although note that this particular cut-out also contains a fused neutral and would therefore be reported under as Code B11.



Category B – Remedial Work

DB work required for you to complete your work

| | |
|--|--|
| Asset Condition Code: B07 | Code Description: DB equipment issue preventing installation/replacement of meter tails |
|--|--|

Note:

DO NOT use this Code:

- If you are not permitted by your company to work on metal-encased cut-outs. Report the issue to your supervisor as per your company procedures;
- For situations where a shared fuse or shared neutral exists. Such situations should be managed in accordance with your company's procedures;
- Where the Meter Operative is not deemed to be competent to undertake the work, i.e. they are not trained to undertake specific work by their company e.g. operate/work on metal-encased cut-outs. This is a Meter Operator issue and does not relate to DB equipment;
- If you do not have the specific tools (e.g. crimper) needed to terminate the meter tails;
- Where the issue involves meter tails between the meter and the customer; equipment and is not DB related. These should be discussed with the customer.

Description:

The meter tail connection from the DB equipment to the meter needs to be replaced. You require the intervention of the DB in order to complete your work. Examples include:

- The connection terminals on the outgoing side of the cut-out are unable to accept a minimum conductor (tails) size of 16mm²;
- The connection in the DB equipment is welded in;
- Terminal screws cannot safely be slackened (e.g. neither fixed nor temporary shrouds are available);
- Holes would be left in metal DB equipment if the tails were to be exchanged and grommets or bushes to fill the entry point are not available;
- A meter position change that would create a potential category A issue that was not previously present and cannot be rectified by the Meter Operative e.g. changing the location of a meter which would expose live conductors in the cut-out that were previously covered by the meter (see example below);
- There are non-standard cable terminations in the DB equipment e.g. 2 meter tails feeding separate properties in the same live port and no second live port available (excluding lugged connections, see note below);

Note: In some circumstances, it may be necessary to make a lugged connection if the DB equipment requires it. If this is the case do not report to DB and obtain the appropriate tools to make the connection;

- The incoming neutral is found to be wired directly to the meter with no termination at the cut-out (excludes supplies provided by rising mains and lateral services, see section below);
- There is (not immediately hazardous) debris within the cut-out or distribution board that poses a risk to its safe operation. Use Code A04 to report issues where hazardous debris provides an immediate risk.



Raised position of meter could create a potential category A issue by leaving exposed live conductor(s) through the cut-out cable entry slot that were previously covered by the meter placed directly on top of the cut-out

Rising Mains and Lateral Services

See also section 1.5.

Rising mains and lateral services are installed in all areas of GB and are used as a means of providing electricity supplies within multi occupancy buildings. The types of buildings which may have rising mains and lateral services installed within them may vary significantly ranging from buildings with as few as two individual properties to large multi storey buildings with hundreds of individual flats.

Defects should only be reported to the DB where it is clear that they are responsible for the operation and maintenance of rising mains and lateral services within the property where a defect has been identified. If the DB is not responsible for the operation and maintenance of rising mains and lateral services within the property a report will need to be sent to the Building Network Owner. If you are unsure regarding who a defect should be reported to contact your supervisor.

There are many different types of rising main and lateral service installations that have been installed across GB. The methods used will typically depend upon; the date of installation, the geographic location and the number of properties within the building. If you need further information regarding these installations contact your supervisor.

In modern installations it is common for isolation to be available adjacent to the meter.

For older installations there may be issues associated with supplies provided by rising main and lateral service installations that differ significantly from other types of supply. These may include:

- No isolation (fuse) or neutral connection (block) is available at the meter position, i.e. the lateral service connections are made direct into the meter;
- No isolation (fuse) is available at the meter position, i.e. the lateral service connections are terminated into connector blocks;
- Isolation is located remotely usually via a multi-phase cut-out or within a multi-service distribution board (BEMCO/ Ryfield etc.);
- Typical lateral service connections into the meter may include;
 - PVC/ XLPE single core cables;
 - VIR insulated single core cables;
 - MICC (pyro cables).

- Isolation is available at the meter position via a red link isolator or fuse unit but no separate neutral block.

Where isolation or neutral connections are not available at the meter position this should not prevent a Meter Operative from installing metering equipment. Refer to your own company's procedures.

Note: In circumstances where the isolation point is located remote from the meter and can be identified, Meter Operatives should apply any isolation required and undertake their metering work.

Do not report these situations to the DB as Code B07.

Where appropriate report as a category C Code, typically:

- C14 (Fed from distribution board – local/remote from meter)
- C15 (DB cable terminating into DB equipment is VIR/MICC)

Actions:

- Wherever possible, for safety and security reasons ensure the DB equipment is sealed before leaving site;
- Stop work and do not commence your meter installation activity;
- Report the issue to the DB via the data flow system – report as Code B07. As this Code can be used for a variety of issues, to ensure the DB is aware of why a seemingly serviceable cut-out should be replaced, it is important to state the reason why in the free text field;
- Provide the DB with the customer's name and contact number using the data flow system;
- To ensure the customer is fully aware of next steps, leave a Category B Customer Notification Card (or equivalent) to advise the customer to expect communication from the DB requesting an appointment to visit site to inspect the DB equipment.

Combined Neutral-Earth Connections with the Potential to Cause Danger

Outgoing neutral conductors from a cut-out to a meter should be continuous neutral and not be combined/connected with earth conductors in a connector block, (or similar).

This configuration of connection can give rise to danger and present an opportunity for illegal abstraction of electricity where the equipment is unsealed.

DO NOT report a B07 Code if:

- bunched earth cables connected to the DB earth block as this can be rectified by the Meter Operative or customer electrician; where necessary.

DO report a B07 if:

- the neutral and earth conductors are connected between the cut-out and meter and irrespective of the earth arrangement. The meter must not be changed and the issue reported to the DB using Code B07.

The B07 report should include an explanation of the issue in the free-text field to assist the DB in determining the actions needed to correct the issue.

For clarity:

- Neutral meter tails must not be connected to DB earth termination blocks
- Customer earth conductors must not be connected into neutral connection blocks
- Meter Operatives must not change the SNE or PME arrangements of any cut-out

The photo below shows an example of the scenario that is reportable to the DB.



Category B – Remedial Work

DB work required for you to complete your work

| | |
|--|---|
| Asset Condition Code: B08 | Code Description: Unhinged metal cut-out cover over un-insulated conductor |
|--|---|

Description:

There is a risk of flash-over where there are un-insulated live conductors and the removal/replacement of the cover is not effectively guided/controlled. For example, an uncommon type of pressed steel metal-encased cut-out (photo below), probably from the 1940s, is known to have this issue.

Examples of where Code B08 should be used, following **INITIAL VISUAL INSPECTION**, are:

- The cut-out or DB distribution board cover is unhinged and it is of a type that it is known that un-insulated live conductors will be present;
- The cover hinges are damaged or broken.

Where the DB equipment **COVER HAS BEEN REMOVED** and the following scenarios are identified, use the associated Code to report the issue/information:

- There is a potential risk of flash-over – report as Code A07;
- The hinges are discovered to be broken – report as Code A04;
- Phase barriers are not present or are damaged – report as Code B03;
- A healthy but unhinged metal-encased cut-out with phase barriers in place as designed – report as Code C06.

You can proceed with your work where the cut-out is unhinged and:

- The DB equipment has adequately insulated live conductors; and
- There are insulated barriers in place, so that the DB equipment cover cannot inadvertently come into contact with exposed un-insulated live conductors.

Actions:

- Wherever possible, for safety and security reasons ensure the DB equipment is sealed before leaving site;
- Stop work and do not commence your meter installation activity;
- Report the issue to the DB via the data flow system – report as Code B08;
- Provide the DB with the customer’s name and contact number using the data flow system;
- To ensure the customer is fully aware of next steps, leave a Category B Customer Notification Card (or equivalent) to advise the customer to expect communication from the DB requesting an appointment to visit site to inspect the DB equipment.

Examples – Unhinged metal cut-out over uninsulated conductors

An uncommon type of pressed steel metal-encased cut-out, probably from the 1940s.



A typical example of a metal-encased cut-out which has known design deficiencies is the ISCO Type cut-out and extreme caution must be exercised when removing or replacing lids on this type of equipment. This particular example also had the phase barriers removed. All cut-outs must be assessed individually prior to attempting any live work on them ensuring that the phase barriers are in place.

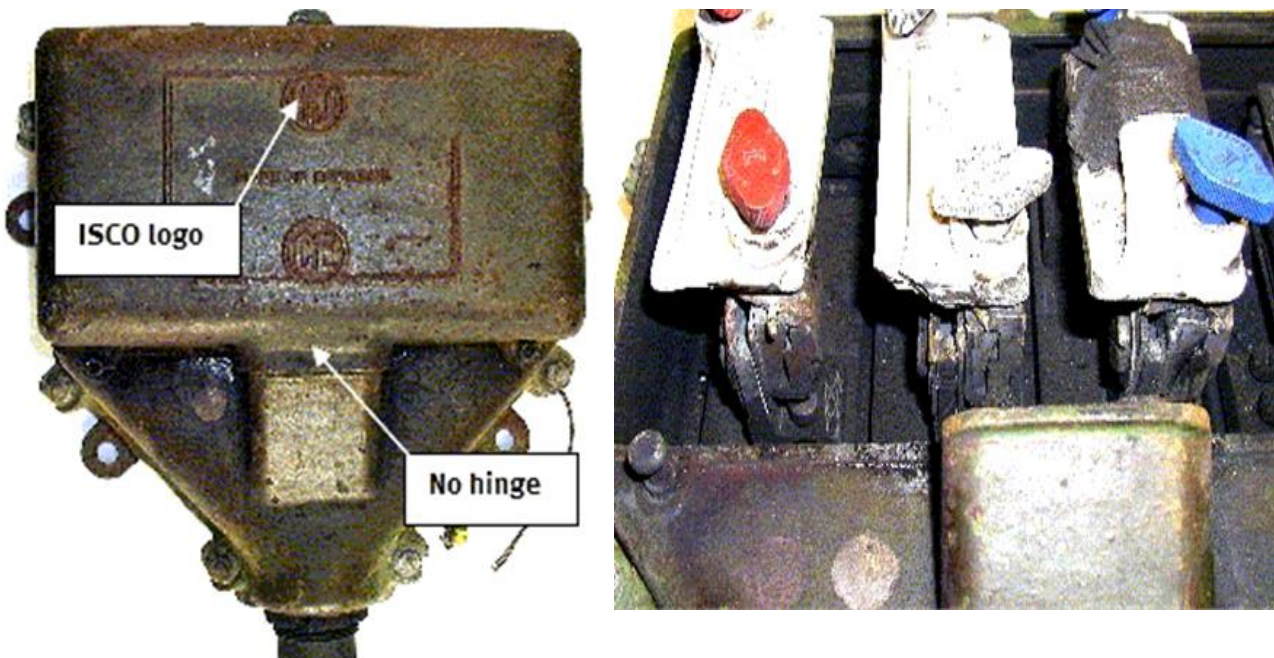

Category B – Remedial Work

DB work required for you to complete your work

| | |
|--|---|
| Asset Condition Code: B10 | Code Description: Unearthed DB metal-encased equipment |
|--|---|

Description:

Any circumstances on the site involving DB equipment that has been identified as unearthed and **NOT LIVE** (e.g. metal-encased cut-out casing). If live report as Code A17.

Note: If the DB equipment which is unearthed is an immediate risk to safety you should report this issue as Code A10 and not this Code.

Actions:

- Wherever possible, for safety and security reasons ensure the DB equipment is sealed before leaving site;
- Stop work and do not commence your meter installation activity;
- Report the issue to the DB via the data flow system – report as Code B10;
- Provide the DB with the customer's name and contact number using the data flow system;
- To ensure the customer is fully aware of next steps, leave a Category B Customer Notification Card (or equivalent) to advise the customer to expect communication from the DB requesting an appointment to visit site to inspect the DB equipment.

Note:

All metalwork associated with the supply should be earthed. The earth connection can be checked with one probe of a test lamp connected to a phase. Although not ideal, metal-encased covers are generally considered earthed when attached to an earthed box.

Category B – Remedial Work

DB work required for you to complete your work

| | |
|--|---|
| Asset Condition Code: B11 | Code Description: Cut-out with a fused neutral |
|--|---|

Description:

Any electricity service cut-out which, when opened, has fuse protection in both the phase and neutral ways. In most cases, these cut-outs will have been installed in pre-1937 properties.

The Electricity Safety, Quality and Continuity Regulations (ESQCR) states that, as of 31st January 2013, fused neutrals must not be retained. There is an HSE requirement for fused neutral cut-outs to be removed within 28 days of being identified.

If you encounter electricity service cut-out which you suspect has withdrawable fuse protection, or a removable link, in the neutral, do not proceed with your work. Make the area safe and immediately report the issue to the network operator via the data flow system as Code B11.

Actions:

- Wherever possible, for safety and security reasons ensure the DB equipment is sealed before leaving site;
- Stop work and do not commence your meter installation activity;
- Report the issue to the DB via the data flow system – report as Code B11;
- Provide the DB with the customer’s name and contact number using the data flow system;
- To ensure the customer is fully aware of next steps, leave a Category B Customer Notification Card (or equivalent) to advise the customer to expect communication from the DB requesting an appointment to visit site to inspect the DB equipment.

Examples:



Category B – Remedial Work

DB work required for you to complete your work

| | |
|--|---|
| Asset Condition Code: B12 | Code Description: DB owned CT metering equipment issue |
|--|---|

Notes:

Current transformer (CT) operated metering equipment may be owned by parties other than the DB (e.g. the customer) – irrespective of ownership, issues involving this equipment should be reported as Code B12.

Issues/information with regard to the incoming service cable and/or cut-out should be reported using the appropriate A, B and C Code.

This Code is not to be used to report a lack of or incomplete DB owned CT metering equipment commissioning or documentation as required under the Balancing and Settlement Code (BSC) CoP4, or where the DB metering equipment does not meet the accuracy requirements of the relevant BSC CoP, but is otherwise safe.

This Code should not be used to inform the DB of installation issues prior to commissioning new CT metering equipment on site as these defects should be communicated via the business as usual processes for new connections.

Where you discover that the building / enclosure housing metering equipment is unsafe you should liaise with the customer to request that these issues are addressed.

Description:

In addition to the supply cut-out / industrial service unit (ISU), for CT operated metering systems, the DB can provide metering equipment typically consisting of, CTs, voltage transformer (VT) (for high voltage systems), test terminal block, local isolation metering potential fuses and link, associated wiring up to and including the test terminal block, and a metering panel. The CTs may be housed in DB switchgear, a CT chamber, ISU or the meter panel.

This Code should be used where the DB owned CT metering equipment is damaged or faulty such that it prevents metering work and/or any subsequent commissioning from being carried out.

For example:

- Damaged or insecure meter panel or CT chamber;
 - Damaged CT or VT;
 - Damaged wiring loom (up to the point of interface, such as the test terminal block and/or fuses/link);
 - Shorting links on CT applied that cannot be accessed by the Meter Operative;
 - Test terminal block missing or faulty;
 - VT primary fuse blown;
 - Inaccessible or non-standard types of VT secondary and LV metering potential fuse blown
- Although VT secondary fuses and metering potential fuses up to and including the point of interface are the responsibility of the DB, normally it would be sensible for the Meter Operative to replace blown fuses, assuming safe access and the operative is confident it is safe to replace (i.e. cause of blown fuse established);

- CT or VT secondary circuit not connected to earth;
- Unexpected voltages or currents at the interface which the Meter Operative is unable to resolve (e.g. indicative of a fault or wiring alterations on the DB side of the interface).

CT installation with missing test terminal block

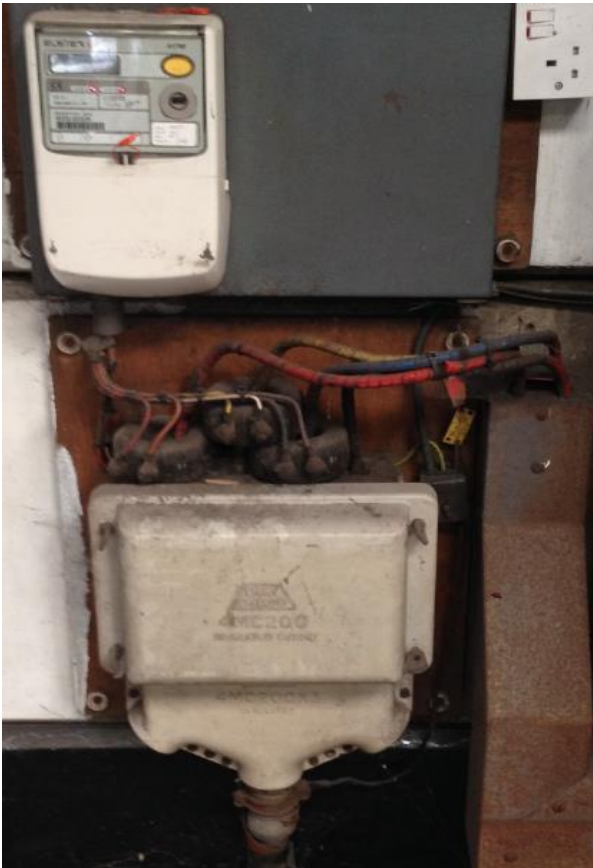

CT wiring insulation damaged by rodent infestation exposing inner conductor



Actions:

- Wherever possible, for safety and security reasons ensure the DB equipment is sealed before leaving site;
- Stop work and do not commence your meter installation activity;
- Report the issue to the DB via the data flow system – report as Code B12. As this Code can be used for a variety of issues please provide a full description in the free text field;
- Provide the DB with the customer's name and contact number using the data flow system;
- To ensure the customer is fully aware of next steps, leave a Category B Customer Notification Card (or equivalent) to advise the customer to expect communication from the DB requesting an appointment to visit site to inspect the DB equipment.

7. Category C Issues/Information

Asset Issue/Information Codes – an issue with/information on the DB equipment that is neither a category A issue nor a category B issue. Report these characteristics to the DB using the data flow process. It is not generally necessary to inform the customer of an Asset Issue/Information Code reported as this may create an unreasonable expectation of DB intervention.

Any actions/work carried out by the Meter Operative at site shall be completed in accordance with their company policies and procedures.

Category C Codes are used to inform the DB of an asset issue/information only and **MUST NOT** prevent your work being carried out.

It is not generally necessary to inform the customer of an Asset Issue/Information Code reported as this may create an unreasonable expectation of DB intervention.

Only report one Code per MPAN e.g. a C Code data flow **SHOULD NOT** be sent if a category A or a B issue has already been reported.

Where there are multiple DB related issues at one MPAN, report the most serious one using the relevant Code. Report the additional issues using the free text field or if reporting a category A issue mention any additional issues to the DB call centre agent.

Ensure that safety and other issues are properly resolved.

When reporting category C (asset issue/information) characteristics, as you can only report one Code per service position, you should report using the highest priority Code and use the free text field to report any additional issues/information.

The priority of C Code reporting is below:

- i. Single insulated DB conductor (phase or non-PME neutral) (C19)
- ii. Missing combined neutral-earth cover on DB equipment (C20)
- iii. Rewirable cut-out fuse (C18)
- iv. Lower rating fuse or cut-out (less than 60A) (C03)
- v. Asbestos component identified in DB equipment (C11)
- vi. Metal-encased cut-out (C06)
- vii. Signs of bitumen compound leaking (C02)
- viii. DB equipment mounted on asbestos board (C16)
- ix. DB equipment unable to be securely sealed (C07)
- x. Black plastic cut-out (C17)
- xi. DB cable terminating into DB equipment is VIR/MICC (C15)
- xii. Fed from distribution board – local/remote from meter (C14)

Note: Category A and B Code reports must always take priority over category C Code reports.

Category C – Asset Issue/Information

Continue with your work but report the issue/information to the DB via data flow

| | |
|--|--|
| Asset Condition Code: C02 | Code Description: Signs of bitumen compound leaking |
|--|--|

Description:

A situation where:

- There is no evidence of the DB equipment currently operating hot;
- The DB equipment appears in all other respects to be in good condition; and
- Compound has obviously leaked from the cut-out previously but is not currently leaking.



If the compound is currently leaking, report as Code A01.

As you can only report one Code per service position, the priority of the below issues/information is in the order that they should be reported. So, for example, if you have identified that there are historic signs of bitumen leaking providing there are no other higher priority issues/information, Code C02 should be reported with details of any other reportable characteristics in the free text field.

The priority of C Code reporting is below:

- i. Single insulated DB conductor (phase or non-PME neutral) (C19)
- ii. Missing combined neutral-earth cover on DB equipment (C20)
- iii. Rewirable cut-out fuse (C18)
- iv. Lower rating fuse or cut-out (less than 60A) (C03)
- v. Asbestos component identified in DB equipment (C11)
- vi. Metal-encased cut-out (C06)
- vii. SIGNS OF BITUMEN COMPOUND LEAKING (C02)**
- viii. DB equipment mounted on asbestos board (C16)
- ix. DB equipment unable to be securely sealed (C07)
- x. Black plastic cut-out (C17)
- xi. DB cable terminating into DB equipment is VIR/MICC (C15)
- xii. Fed from distribution board – local/remote from meter (C14)

Note: Category A and B Code reports must always take priority over category C Code reports.

Actions:

- Continue with your work;
- Report the issue/information to the DB via the data flow system – report as Code C02;
- Provide the DB with the customer's name and contact number using the data flow system;
- It is not generally necessary to inform the customer of an Asset Issue/Information Code reported as this may create an unreasonable expectation of DB intervention.

Category C – Asset Issue/Information

Continue with your work but report the issue/information to the DB via data flow

| | |
|--|---|
| Asset Condition Code: C03 | Code Description: Lower rating fuse or cut-out (less than 60A) |
|--|---|

Description:

Any service DB equipment where when the fuse carrier is removed or the DB equipment cover is opened, it is evident that the fuse has a maximum rating of less than 60 amps, look for:

- Indication on the face of the cut-out that the rating is less than 60 amps;
- Indication on the fuse that its rating is less than 60 amps.

As well as being used to report small fuses, this Code must also be used to report situations where the cut-out is rated at less than 60 amps. Look for an indication on the DB equipment (moulding or name-plate) by the manufacturer that the cut-out rating is less than 60 amps.

As you can only report one Code per service position, the priority of the below issues/information is in the order that they should be reported. So, for example, if you have identified that the fuse or cut-out is rated at less than 60A providing there are no other higher priority issues/information, Code C03 should be reported with details of any other reportable characteristics in the free text field.

The priority of C Code reporting is below:

- i. Single insulated DB conductor (phase or non-PME neutral (C19)
- ii. Missing combined neutral-earth cover on DB equipment (C20)
- iii. Rewirable cut-out fuse (C18)
- iv. LOWER RATING FUSE OR CUT-OUT (LESS THAN 60A) (C03)**
- v. Asbestos component identified in DB equipment (C11)
- vi. Metal-encased cut-out (C06)
- vii. Signs of bitumen compound leaking (C02)
- viii. DB equipment mounted on asbestos board (C16)
- ix. DB equipment unable to be securely sealed (C07)
- x. Black plastic cut-out (C17)
- xi. DB cable terminating into DB equipment is VIR/MICC (C15)
- xii. Fed from distribution board – local/remote from meter (C14)

Note: Category A and B Code reports must always take priority over category C Code reports.

Actions:

- Continue with your work;
- Report the issue/information to the DB via the data flow system – report as Code C03;
- Provide the DB with the customer's name and contact number using the data flow system;
- It is not generally necessary to inform the customer of an Asset Issue/Information Code reported as this may create an unreasonable expectation of DB intervention.

Category C – Asset Issue/Information

Continue with your work but report the issue/information to the DB via data flow

| | |
|--|--|
| Asset Condition Code: C06 | Code Description: Metal-encased cut-out |
|--|--|

Description:

Any property where:

- The electricity service cut-out is manufactured from a metallic base material; and
- The DB equipment has not been identified as having a category A (emergency) or B (remedial work) issue.

For the avoidance of doubt, **DO NOT** report metal-encased distribution boards.

Examples of a metal-encased cut-out include:

- Pressed steel boxes;
- Cast metal boxes.

As you can only report one Code per service position, the priority of the below issues/information is in the order that they should be reported. So, for example, if you have identified that the cut-out is metal-encased providing there are no other higher priority issues/information, Code C06 should be reported with details of any other reportable characteristics in the free text field.

The priority of C Code reporting is below:

- i. Single insulated DB conductor (phase or non-PME neutral (C19)
- ii. Missing combined neutral-earth cover on DB equipment (C20)
- iii. Rewirable cut-out fuse (C18)
- iv. Lower rating fuse or cut-out (less than 60A) (C03)
- v. Asbestos component identified in DB equipment (C11)
- vi. METAL-ENCASED CUT-OUT (C06)**
- vii. Signs of bitumen compound leaking (C02)
- viii. DB equipment mounted on asbestos board (C16)
- ix. DB equipment unable to be securely sealed (C07)
- x. Black plastic cut-out (C17)
- xi. DB cable terminating into DB equipment is VIR/MICC (C15)
- xii. Fed from distribution board – local/remote from meter (C14)

Note: Category A and B Code reports must always take priority over category C Code reports.

Actions:

- Continue with your work;
- Report the issue/information to the DB via the data flow system – report as Code C06;
- Provide the DB with the customer's name and contact number using the data flow system;
- It is not generally necessary to inform the customer of an Asset Issue/Information Code reported as this may create an unreasonable expectation of DB intervention.

Category C – Asset Issue/Information

Continue with your work but report the issue/information to the DB via data flow

| | |
|--|--|
| Asset Condition Code: C07 | Code Description: DB equipment unable to be securely sealed |
|--|--|

Description:

Where the sealing tag on the DB equipment is broken, or the DB equipment is otherwise unable to be effectively sealed.

Sealing

Sealing achieves four purposes:

- a) To ensure basic safety – access to live conductors should require a tool;
- b) To provide an indication of responsibility and/or the right to operate;
- c) To aid with the prevention of tampering/illegal abstraction; and
- d) To indicate the MOCOPA Party and individual to last access the metering equipment or DB equipment at the site, in the event of a dispute.

MOCOPA® describes the obligations on parties regarding sealing metering equipment such as the use of individually issued and registered sealing pliers. Cut-out fuse carriers can be fitted with “tags”, e.g. top and bottom. Where they are, this enables wire and ferrule seals to be applied.

Examples: Photos showing where the tags are broken and it is not possible to seal the cut-out properly.



As you can only report one Code per service position, the priority of the below issues/information is in the order that they should be reported. So, for example, if you have identified that the cut-out cannot be effectively sealed providing there are no other higher priority issues/information, Code C07 should be reported with details of any other reportable characteristics in the free text field.

The priority of C Code reporting is below:

- i. Single insulated DB conductor (phase or non-PME neutral) (C19)
- ii. Missing combined neutral-earth cover on DB equipment (C20)
- iii. Rewirable cut-out fuse (C18)
- iv. Lower rating fuse or cut-out (less than 60A) (C03)
- v. Asbestos component identified in DB equipment (C11)
- vi. Metal-encased cut-out (C06)
- vii. Signs of bitumen compound leaking (C02)
- viii. DB equipment mounted on asbestos board (C16)
- ix. DB EQUIPMENT UNABLE TO BE SECURELY SEALED (C07)**
- x. Black plastic cut-out (C17)
- xi. DB cable terminating into DB equipment is VIR/MICC (C15)
- xii. Fed from distribution board – local/remote from meter (C14)

Note: Category A and B Code reports must always take priority over category C Code reports.

Actions:

- Continue with your work;
- Consider alternative means of sealing, to leave the site safe. Adhesive sealing labels are an appropriate temporary alternative if one or more sealing points are damaged or if the remaining sealing points do not restrict access;
- Report the issue/information to the DB via the data flow system – report as Code C07;
- Provide the DB with the customer's name and contact number using the data flow system;
- It is not generally necessary to inform the customer of an Asset Issue/Information Code reported as this may create an unreasonable expectation of DB intervention.

Category C – Asset Issue/Information

Continue with your work but report the issue/information to the DB via data flow

| | |
|--|--|
| Asset Condition Code: C11 | Code Description: Asbestos component identified in DB equipment |
|--|--|

Description:

On removing the cut-out or distribution board cover or fuse (usually in metal-encased cut-outs) materials used for the phase barriers or as arc suppression or protection from heat are suspected to be manufactured from asbestos containing material.

Note: If the asbestos is damaged; report as Code A12.

For more information on asbestos procedures, refer to the note on the guidance sheet for Code A12.

Examples – Asbestos component in DB equipment

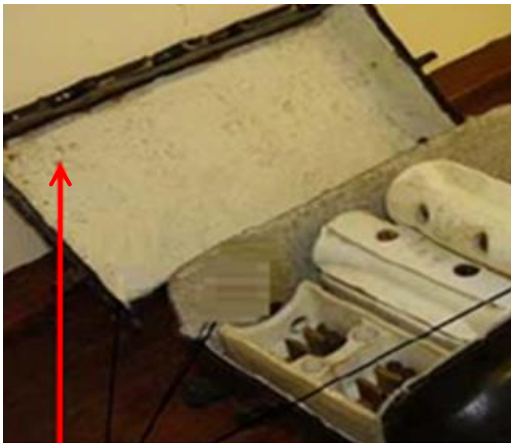

Coating and labels

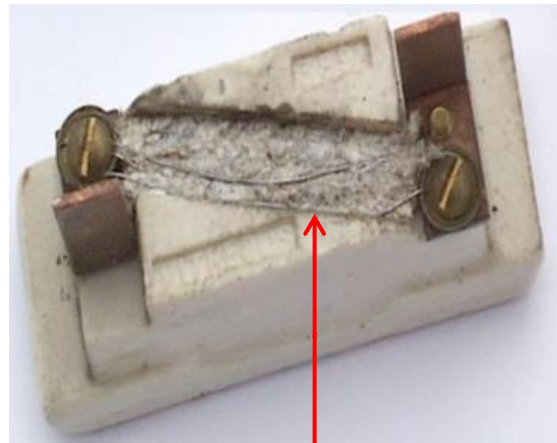

Asbestos wool

Asbestos phase barrier



As you can only report one Code per service position, the priority of the below issues/Information is in the order that they should be reported. So, for example, if you have identified that the cut-out contains asbestos components providing there are no other higher priority issues/information, Code C11 should be reported with details of any other reportable characteristics in the free text field.

The priority of C Code reporting is below:

- i. Single insulated DB conductor (phase or non-PME neutral (C19)
- ii. Missing combined neutral-earth cover on DB equipment (C20)
- iii. Rewirable cut-out fuse (C18)
- iv. Lower rating fuse or cut-out (less than 60A) (C03)
- v. **ASBESTOS COMPONENT IDENTIFIED IN DB EQUIPMENT (C11)**
- vi. Metal-encased cut-out (C06)
- vii. Signs of bitumen compound leaking (C02)
- viii. DB equipment mounted on asbestos board (C16)
- ix. DB equipment unable to be securely sealed (C07)
- x. Black plastic cut-out (C17)
- xi. DB cable terminating into DB equipment is VIR/MICC (C15)
- xii. Fed from distribution board – local/remote from meter (C14)

Note: Category A and B Code reports must always take priority over category C Code reports.

Actions:

- Continue with your work;
- Report the issue/information to the DB via the data flow system – report as Code C11;
- Follow your company procedure for dealing with asbestos;
- Provide the DB with the customer's name and contact number using the data flow system;
- It is not generally necessary to inform the customer of an Asset Issue/Information Code reported as this may create an unreasonable expectation of DB intervention.

An AMO document “Guidance to manage asbestos during metering activities” provides guidance to companies in developing their own asbestos safe working procedures. This will allow your company to update their asbestos procedures, which you must follow in the event of encountering asbestos-based materials.

Category C – Asset Issue/Information

Continue with your work but report the issue/information to the DB via data flow

| | |
|--|--|
| Asset Condition Code: C14 | Code Description: Fed from distribution board – local/remote from meter |
|--|--|

Description:

The service cable is fed from an internal distribution board within the building. Use this Code when the distributors' fuse, which supplies the customer, sits in a distribution board. This includes:

- Landlord distribution boards (Building Network Operator);
- Meters relying on a distribution board fuse for protection, regardless of whether the meter has local isolation; and
- DB owned distribution boards.



As you can only report one Code per service position, the priority of the below issues/information is in the order that they should be reported. So, for example, if you have identified that the service cable is fed from a distribution board providing there are no other higher priority issues/information, Code C14 should be reported with details of any other reportable characteristics in the free text field.

The priority of C Code reporting is below:

- i. Single insulated DB conductor (phase or non-PME neutral) (C19)
- ii. Missing combined neutral-earth cover on DB equipment (C20)
- iii. Rewirable cut-out fuse (C18)
- iv. Lower rating fuse or cut-out (less than 60A) (C03)
- v. Asbestos component identified in DB equipment (C11)
- vi. Metal-encased cut-out (C06)
- vii. Signs of bitumen compound leaking (C02)
- viii. DB equipment mounted on asbestos board (C16)
- ix. DB equipment unable to be securely sealed (C07)
- x. Black plastic cut-out (C17)
- xi. DB cable terminating into DB equipment is VIR/MICC (C15)
- xii. **FED FROM DISTRIBUTION BOARD – LOCAL/REMOTE FROM METER (C14)**



Note: Category A and B Code reports must always take priority over category C Code reports.

Actions:

- Continue with your work;
- Report the issue/information to the DB via the data flow system – report as Code C14;
- Provide the DB with the customer's name and contact number using the data flow system;
- It is not generally necessary to inform the customer of an Asset Issue/Information Code reported as this may create an unreasonable expectation of DB intervention.

Category C – Asset Issue/Information

Continue with your work but report the issue/information to the DB via data flow

| | |
|--|---|
| Asset Condition Code: C15 | Code Description: DB cable terminating into DB equipment is VIR/MICC |
|--|---|

This Code should be used for reporting service cables which are in a serviceable condition but provided via:

- Mineral Insulated Copper Clad cable (MICC, sometimes known as Pyro);
- Vulcanised India Rubber (VIR) conductors.

Examples – MICC and VIR cables

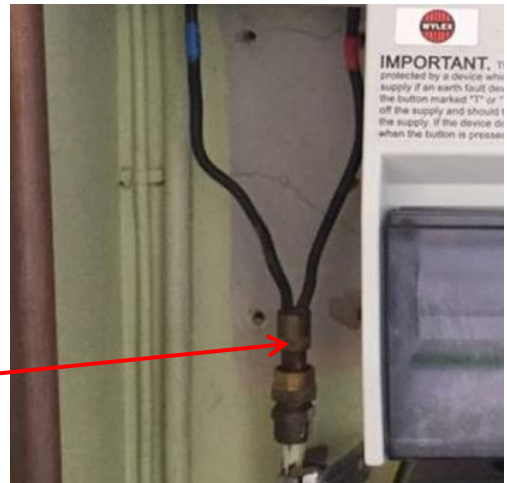

Examples of MICC cable

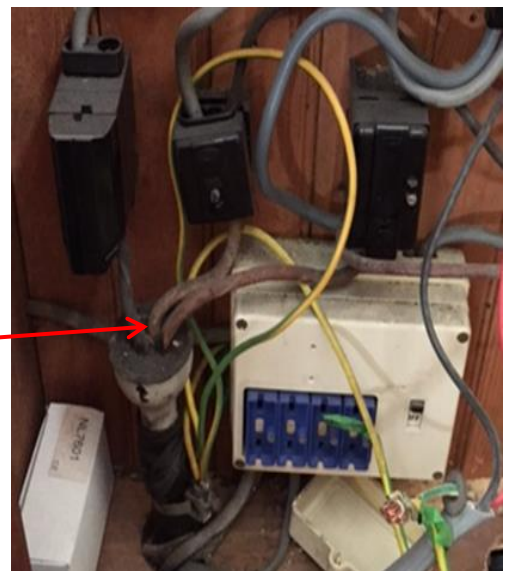

Example of VIR covered conductors

Description:

The final service cable to the cut-out (sometimes referred to as 'lead-in') can be:

- The cable between the overhead line and the cut-out; or
- Looped from another cut-out.

VIR installations are commonly:

- Found in older properties;
- Fed by an overhead service; or
- Found in multiple-occupancy buildings.

Note: THIS CODE SHOULD ONLY BE USED TO REPORT DB SERVICE CABLE INFORMATION, NOT BUILDING NETWORK OPERATOR EQUIPMENT.

Old overhead (VIR) service neutrals were sometimes terminated directly into the meter (no neutral block). Do not attempt to carry out any work, but report as Code B07.

As you can only report one Code per service position, the priority of the below issues/information is in the order that they should be reported. So, for example, if you have identified that the service cable is fed from a distribution board providing there are no other higher priority issues/information, Code C15 should be reported with details of any other reportable characteristics in the free text field.

The priority of C Code reporting is below:

- i. Single insulated DB conductor (phase or non-PME neutral (C19)
- ii. Missing combined neutral-earth cover on DB equipment (C20)
- iii. Rewirable cut-out fuse (C18)
- iv. Lower rating fuse or cut-out (less than 60A) (C03)
- v. Asbestos component identified in DB equipment (C11)
- vi. Metal-encased cut-out (C06)
- vii. Signs of bitumen compound leaking (C02)
- viii. DB equipment mounted on asbestos board (C16)
- ix. DB equipment unable to be securely sealed (C07)
- x. Black plastic cut-out (C17)
- xi. DB CABLE TERMINATING INTO DB EQUIPMENT IS VIR/MICC (C15)**
- xii. Fed from distribution board – local/remote from meter (C14)

Note: Category A and B Code reports must always take priority over category C Code reports.

Actions:

- Continue with your work;
- Report the issue/information to the DB via the data flow system – report as Code C15;
- Provide the DB with the customer's name and contact number using the data flow system;
- It is not generally necessary to inform the customer of an Asset Issue/Information Code reported as this may create an unreasonable expectation of DB intervention.

Category C – Asset Issue/Information

Continue with your work but report the issue/information to the DB via data flow

| | |
|--|---|
| Asset Condition Code: C16 | Code Description: DB equipment mounted on asbestos board |
|--|---|

Description:

Following an on-site assessment you identify that the board to which the DB equipment is fixed is manufactured from Asbestos Containing Materials (ACM).



As you can only report one Code per service position, the priority of the below issues/information is in the order that they should be reported. So, for example, if you have identified that the cut-out may be mounted on an asbestos board providing there are no other higher priority issues/information, Code C16 should be reported with details of any other reportable characteristics in the free text field.

The priority of C Code reporting is below:

- i. Single insulated DB conductor (phase or non-PME neutral (C19)
- ii. Missing combined neutral-earth cover on DB equipment (C20)
- iii. Rewirable cut-out fuse (C18)
- iv. Lower rating fuse or cut-out (less than 60A) (C03)
- v. Asbestos component identified in DB equipment (C11)
- vi. Metal-encased cut-out (C06)
- vii. Signs of bitumen compound leaking (C02)
- viii. DB EQUIPMENT MOUNTED ON ASBESTOS BOARD (C16)**
- ix. DB equipment unable to be securely sealed (C07)
- x. Black plastic cut-out (C17)
- xi. DB cable terminating into DB equipment is VIR/MICC (C15)
- xii. Fed from distribution board – local/remote from meter (C14)

Note: Category A and B Code reports must always take priority over category C Code reports.

Actions:

- If your company procedures allow, continue with your work;
- Report the issue/information to the DB via the data flow system – report as Code C16;
- Record in the free text field if you believe the ACM board is damaged;
- Provide the DB with the customer’s name and contact number using the data flow system;
- It is not generally necessary to inform the customer of an Asset Issue/Information Code reported as this may create an unreasonable expectation of DB intervention.

Category C – Asset Issue/Information

Continue with your work but report the issue/information to the DB via data flow

| | |
|--|--|
| Asset Condition Code: C17 | Code Description: Black plastic cut-out |
|--|--|

Description:

Black plastic cut-outs made from phenolic materials were installed by DBs across the UK around the period 1967 and 1992. A potential safety issue has been identified with black phenolic plastic cut-outs, whereby the plastic casing can in some circumstances become conductive leading to a risk of electric shock and / or excessive heat. This particular issue must be reported as Code A19.

The purpose of this Code is to identify all cut-outs that might be of a black plastic phenolic type.

Initial Checks:

If as part of your risk assessment of the work area, you identify that the cut-out is a black plastic cut-out that may contain phenolic material then follow these actions:

- Before the operation of a cut-out - check for surface voltage on the body of the black plastic cut-out using an appropriate direct contact voltage measuring device (do not operate the DB equipment if a voltage is detected);
- Where the test has been confirmed in accordance with the guidance in Code A19, do not operate the DB equipment, and contact the DB immediately by telephone reporting as Code A19;
- Only operate the DB equipment when you are satisfied there is no sustained surface voltage present;
- Where no sustained surface voltage is recorded and it is safe to continue with your work, it is appropriate to report this Code.

Examples: Black plastic cut-outs that might be a phenolic type are shown below.



As you can only report one Code per service position, the priority of the below issues/information is in the order that they should be reported. So, for example, if you have identified that the cut-out is black plastic, providing there are no other higher priority issues/information, Code C17 should be reported with details of any other reportable characteristics in the free text field.

The priority of C Code reporting is below:

- i. Single insulated DB conductor (phase or non-PME neutral (C19)
- ii. Missing combined neutral-earth cover on DB equipment (C20)
- iii. Rewirable cut-out fuse (C18)
- iv. Lower rating fuse or cut-out (less than 60A) (C03)
- v. Asbestos component identified in DB equipment (C11)
- vi. Metal-encased cut-out (C06)
- vii. Signs of bitumen compound leaking (C02)
- viii. DB equipment mounted on asbestos board (C16)
- ix. DB equipment unable to be securely sealed (C07)
- x. **BLACK PLASTIC CUT-OUT (C17)**
- xi. DB cable terminating into DB equipment is VIR/MICC (C15)
- xii. Fed from distribution board – local/remote from meter (C14)

Note: Category A and B Code reports must always take priority over category C Code reports.

Actions:

- Only operate the DB equipment when you are satisfied there is no sustained surface voltage present;
- Continue with your work;
- Report the issue/information to the DB via the data flow system – report as Code C17;
- Provide the DB with the customer's name and contact number using the data flow system;
- It is not generally necessary to inform the customer of an Asset Issue/Information Code reported as this may create an unreasonable expectation of DB intervention.

Category C – Asset Issue/Information

Continue with your work but report the issue/information to the DB via data flow

| | |
|--|---|
| Asset Condition Code: C18 | Code Description: Rewirable cut-out fuse |
|--|---|

Description:

Any DB service equipment where, when the fuse carrier is removed, or the DB equipment cover is opened, it is evident that the fuse is of the rewirable type (of any rating).

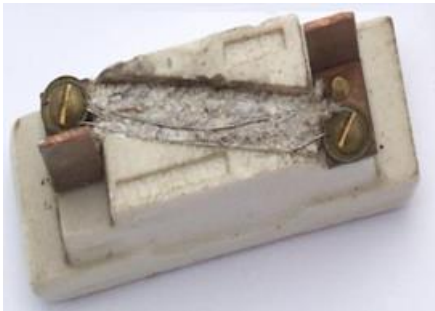

As you can only report one Code per service position, the priority of the below issues/information is in the order that they should be reported. So, for example, if you have identified that the cut-out has a rewirable fuse, providing there are no other higher priority issues/information, Code C18 should be reported with details of any other reportable characteristics in the free text field.

The priority of C Code reporting is below:

- i. Single insulated DB conductor (phase or non-PME neutral) (C19)
- ii. Missing combined neutral-earth cover on DB equipment (C20)
- iii. REWIREABLE CUT-OUT FUSE (C18)**
- iv. Lower rating fuse or cut-out (less than 60A) (C03)
- v. Asbestos component identified in DB equipment (C11)
- vi. Metal-encased cut-out (C06)
- vii. Signs of bitumen compound leaking (C02)
- viii. DB equipment mounted on asbestos board (C16)
- ix. DB equipment unable to be securely sealed (C07)
- x. Black plastic cut-out (C17)
- xi. DB cable terminating into DB equipment is VIR/MICC (C15)
- xii. Fed from distribution board – local/remote from meter (C14)

Note: Category A and B Code reports must always take priority over category C Code reports.

Actions:

- Continue with your work;
- Report the issue/information to the DB via the data flow system – report as Code C18;
- Provide the DB with the customer’s name and contact number using the data flow system;
- It is not generally necessary to inform the customer of an Asset Issue/Information Code reported as this may create an unreasonable expectation of DB intervention.

Category C – Asset Issue/Information

Continue with your work but report the issue/information to the DB via data flow

| | |
|--|---|
| Asset Condition Code: C19 | Code Description: Single insulated DB conductor (phase or non-PME neutral) |
|--|---|

Note:

For clarification of a non-PME service, refer to ‘Explanation of earthing arrangements’ in Code A07.

Description:

This Code should be used for reporting incoming service cables to the DB equipment which are in a serviceable condition but have single insulation covering the conductor(s) and are not mechanically protected.

Examples where there is no mechanical protection include:

- Missing service cable crutch cover (on non-PME service);
- Insulated trousers which have slipped down the service cable crutch.

Do not report single insulated combined neutral-earth conductors associated with PME electricity services as these are not considered to be live conductors.

Report exposed combined neutral-earth conductors associated with PME electricity services as Code C20 if not mechanically protected.

Examples – single insulated service cables

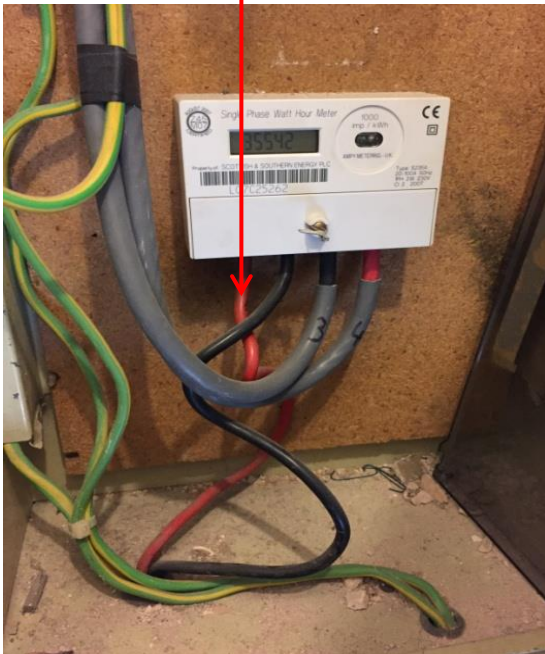

As you can only report one Code per service position, the priority of the below issues/information is in the order that they should be reported. So, for example, if you have identified that the cut-out has a single insulated conductor, providing there is no category A or B issues present, Code C19 should be reported with details of any other reportable characteristics in the free text field.

The priority of C Code reporting is below:

- i. **SINGLE INSULATED DB CONDUCTOR (PHASE OR NON-PME NEUTRAL) (C19)**
- ii. Missing combined neutral-earth cover on DB equipment (C20)
- iii. Rewirable cut-out fuse (C18)
- iv. Lower rating fuse or cut-out (less than 60A) (C03)
- v. Asbestos component identified in DB equipment (C11)
- vi. Metal-encased cut-out (C06)
- vii. Signs of bitumen compound leaking (C02)
- viii. DB equipment mounted on asbestos board (C16)
- ix. DB equipment unable to be securely sealed (C07)
- x. Black plastic cut-out (C17)
- xi. DB cable terminating into DB equipment is VIR/MICC (C15)
- xii. Fed from distribution board – local/remote from meter (C14)

Note: Category A and B Code reports must always take priority over category C Code reports.

Actions:

- Continue with your work;
- Report the issue/information to the DB via the data flow system – report as Code C19;
- Provide the DB with the customer's name and contact number using the data flow system;
- It is not generally necessary to inform the customer of an Asset Issue/Information Code reported as this may create an unreasonable expectation of DB intervention.

Category C – Asset Issue/Information

Continue with your work but report the issue/information to the DB via data flow

| | |
|--|---|
| Asset Condition Code: C20 | Code Description: Missing combined neutral-earth cover on DB equipment |
|--|---|

Description:

This Code should be used for reporting combined neutral-earth covers on DB equipment that by design should not be missing.

This Code should only be used for combined neutral-earth (PME) systems.

Examples where Code C20 **SHOULD** be used are:

- Missing combined neutral-earth covers forming part of the DB equipment;
- Missing cut-out crutch cover where no other protection is installed (e.g. insulated ‘Y piece’ shroud) and the neutral-earth conductor is un-insulated;
- Missing neutral-earth terminal access covers that cannot be remediated by the Meter Operative.



Examples where Code C20 **SHOULD NOT** be used are:

- All exposed neutral conductors associated with non-PME supplies (this should be reported as Code A07);
- By design un-insulated earth blocks;
- Missing insulated earth block covers.

As you can only report one Code per service position, the priority of the below issues/information is in the order that they should be reported. So, for example, if you have identified that the cut-out has missing combined neutral-earth cover, providing there are no other higher priority issues/information, Code C20 should be reported with details of any other reportable characteristics in the free text field.

The priority of C Code reporting is below:

- i. Single insulated DB conductor (phase or non-PME neutral (C19)
- ii. **MISSING COMBINED NEUTRAL-EARTH COVER ON DB EQUIPMENT (C20)**
- iii. Rewirable cut-out fuse (C18)
- iv. Lower rating fuse or cut-out (less than 60A) (C03)
- v. Asbestos component identified in DB equipment (C11)
- vi. Metal-encased cut-out (C06)
- vii. Signs of bitumen compound leaking (C02)
- viii. DB equipment mounted on asbestos board (C16)
- ix. DB equipment unable to be securely sealed (C07)
- x. Black plastic cut-out (C17)
- xi. DB cable terminating into DB equipment is VIR/MICC (C15)
- xii. Fed from distribution board – local/remote from meter (C14)

Note: Category A and B Code reports must always take priority over category C Code reports.

Actions:

- Continue with your work;
- Report the issue/information to the DB via the data flow system – report as Code C20;
- Provide the DB with the customer's name and contact number using the data flow system;
- It is not generally necessary to inform the customer of an Asset Issue/Information Code reported as this may create an unreasonable expectation of DB intervention.

Appendix I

Commonly Used Terms

| | |
|---------------------|--|
| AIB | Asbestos Insulated Board |
| ACM | Asbestos Containing Material |
| AMO | Association of Meter Operators |
| BNO | Building Network Operator |
| Code | Asset condition code |
| DCUSA | Distribution Connection and Use of System Agreement |
| DB | Distribution Business |
| DB | Distribution Network Operator (referred to as DB in MOCOPA [®] and this document) |
| DTC | Data Transfer Catalogue |
| ENA | Energy Networks Association |
| ESQCR | Electricity Safety, Quality and Continuity Regulations |
| HSE | Health and Safety Executive |
| IDB | Independent Distribution Network Operator |
| MICC | Mineral Insulated Copper Clad |
| MO | Meter Operator/Operative |
| MOCOPA [®] | Meter Operation Code of Practice Agreement |
| MPAN | Meter Point Administration Number |
| MRA | Master Registration Agreement |
| PME | Protective Multiple Earthing |
| PPE | Personal Protective Equipment |
| SFIC | Safety and Faults Information Centre |
| SLA | Service Level Agreement as defined in DCUSA |
| VIR | Vulcanised India Rubber |

Appendix II

Identifying the Distribution Business

The DB can be identified from the first two digits of the MPAN:

| | | | |
|-----------|------------------|------------|------------|
| <u>S</u> | <u>00</u> | <u>111</u> | <u>222</u> |
| <u>13</u> | <u>1234 5678</u> | | <u>345</u> |

| First 2 digits | Area | Distribution Network Operators (DBs) |
|----------------|------------------------------------|---|
| 10 | Eastern England | UK Power Networks (UKPN) – Eastern Power Networks (EPN) |
| 11 | East Midlands | Western Power Distribution (WPD) – East Midlands |
| 12 | London | UK Power Networks (UKPN) – London Power Networks (LPN) |
| 13 | Cheshire, Merseyside & North Wales | SP Energy Networks (SPM) – Cheshire, Merseyside and North Wales |
| 14 | West Midlands | Western Power Distribution (WPD) – West Midlands |
| 15 | North Eastern England | Northern Powergrid (NPg) |
| 16 | North Western England | Electricity North West (ENW) |
| 17 | Northern Scotland | Scottish and Southern Electricity Networks– Scottish Hydro Electric Power |
| 18 | Southern Scotland | SP Energy Networks (SPD) |
| 19 | South Eastern England | UK Power Networks (UKPN) – South Eastern Power Networks (SPN) |
| 20 | Southern England | Scottish and Southern Electricity Networks – Southern Electric Power |
| 21 | South Wales | Western Power Distribution (WPD) – South Wales |
| 22 | South West England | Western Power Distribution (WPD) – South West |
| 23 | Yorkshire | Northern Powergrid (NPg) |

| First 2 digits | Independent Distribution Network Operators (IDBs) |
|----------------|---|
| 24 | Independent Power Networks Ltd |
| 25 | ESP Electricity |
| 26 | Last Mile Electricity Ltd |
| 27 | The Electricity Network Company Ltd |
| 28 | UK Power Networks (iDB) Ltd |
| 29 | Harlaxton Energy Networks Ltd |
| 30 | Leep Electricity Networks Ltd |
| 31 | UK Power Distribution Ltd |

| | |
|----|--------------------------------|
| 32 | Energy Assets Networks Ltd |
| 33 | Eclipse Power Network Ltd |
| 34 | Murphy Power Distribution Ltd |
| 35 | Fulcrum Electricity Assets Ltd |
| 36 | Vattenfall Networks Ltd |
| 37 | Forbury Assets Ltd |
| | Utility Assets Network Ltd |

Current emergency, Meter Operative A Code reporting and Customer enquiry following category A or B Code Notification Card(s) telephone numbers are available on the MOCOPA website:

<https://mocopa.org.uk/parties-area/distribution-business-information/>

The link is only available to users with access to the MOCOPA Parties Area.

Please note emergency telephone numbers are liable to change from time to time.

Appendix III

Category A Customer Notification Card

Visit Required by the Electricity Network Operator

- During the meter installation visit, an issue has been discovered that needs to be investigated/resolved by, the network operator who manage the local electricity network which delivers power to your home.
- The equipment in your home is in a safe condition and your network operator has been contacted to make them aware of the situation. They will be in contact with you **within the next few hours** to inspect their equipment, and carry out any necessary work.
- To carry out the work your network operator will need access to your home so please ensure that an adult is available to provide access.
- Following confirmation from the network operator that their work has been completed, and the new meter has not already been installed, your electricity supplier will contact you to arrange a further visit to complete the meter installation.

If you need to contact your network operator regarding their visit, please call

quoting reference number

Category A report

Category B Customer Notification Card

Visit Required by the Electricity Network Operator

- During the meter installation visit, an issue has been discovered that needs to be investigated/resolved by, the network operator, who manage the local electricity network which delivers power to your home.
- The equipment in your home is in a safe condition and your network operator will be contacted within the next five working days to make them aware of the situation. They will be in contact with you **within the next three weeks** to arrange a visit to inspect their equipment, and carry out any necessary work.
- To carry out the work your network operator will need access to your home so please ensure that an adult is available to provide access.
- Following confirmation from the network operator that their work has been completed, your electricity supplier will contact you to arrange a further visit to complete the meter installation.

If you need to contact the network operator regarding their visit, please call
 **quoting the following Meter Point Administration**
Number (MPAN)

Category B report

Appendix IV

Categorisation of a Vulnerable Customer

| Category | Group |
|--|-------------------------------|
| Heart/ Lung & Ventilator | Medically Dependent Equipment |
| Dialysis, Feeding Pump & Auto Medication | |
| Nebuliser and Apnoea Monitor | |
| Oxygen Concentrator | |
| Medicine Refrigeration | |
| Careline/ Telecare System | |
| MDE Electric Showering | |
| Stair Lift/ Hoist/ Electric Bed | |
| Chronic/ Serious Illness | Chronic/ Serious Illness |
| Post Hospital Recovery | Temporary |
| Life Changes | |
| Young Adult Householder | |
| Physical Impairment | Poor Mobility |
| Unable to Answer Door/ Restricted Movement | |
| Restricted Hand Movement | |
| Oxygen Use | Safety |
| Poor Sense of Smell | |
| Dementia(s) | Industry Shared Best Practice |
| Mental Health | |
| Developmental Condition | |
| Additional Presence Preferred | |
| Pensionable Age | Age Related |
| Children Under Five | |
| Blind | Communications |
| Hearing/ Speech Difficulties | |
| Partially Sighted | |
| Unable to Communicate in English | |